

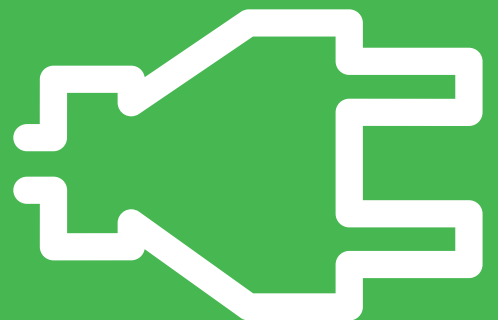

 Price List

Final Distribution, Wiring Devices and Lighting Control Products

With effect from January 15th, 2026



Acti 9 Distribution System	4
Miniature Circuit Breakers (MCBs).....	8
Residual Current Devices (RCDs).....	11
Arc fault Detection Device (AFDD).....	14
Auxiliaries and Accessories for MCBs / RCDs	15
Surge Protection Devices.....	17
Control and Command Products.....	19
ComReady Control and Command Products.....	21
Isobar Distribution System	22
Acti 9 Isobar Pan Assembly	24
Acti 9 Distribution Boards.....	25
Acti 9 Modular Distribution Boards - Metallic.....	29
Timers & Time Switches	36
Kaedra Enclosures	38
Weather Proof	38
PratiKa.....	40
Plugs and Sockets - IP44 / IP67	40
Electra	44
Metal Clad Plugs & Sockets	44
56 Series	45
Plugs and Sockets - IP56 / IP66	45
Wiring Devices	48
LIVIA - Switch to the extra-ordinary.....	49
Miluz Lara	51
Opale - Switches with Satin Finish	55
Unica Pure - Irresistibly Beautiful	57
ZENcelo India - The Revolutionary Full-Flat Switch	65
AvatarOn - It's also a Switch.....	69
Kavacha - Weather Protected Series.....	76
Metal Boxes	77
Smart Home Energy Management System	78
Wiser™.....	82
Surface and Flush Mount Occupancy Sensors.....	83
Dimmable Sensors with Light Regulation.....	83
Wall Mount Sensors.....	84
Hotel - ELV Dual Motion Sensor	84

Acti 9 | Advanced Communication Technology that Inspires

> Protection devices

- Miniature circuit breakers
- Residual current circuit breakers
- Vigi™ residual current devices
- Surge Protection Devices

> Protection monitoring and supervision

- Indication and tripping auxiliaries
- Remote control auxiliaries
- Automatic reclosure auxiliaries



Innovative
Protection monitoring Total control and
Metering @ DB level



Efficient
Manage loads, reduce operating and project
costs, and accurately plan maintenance

> Control and monitoring

- Contactors
- Impulse relays
- Integrated control circuit breakers
- Light indicators
- Push-buttons and selector switches
- Communication Architecture

> Installation system

- IP20B terminals
- Splitter blocks
- Full range of mounting and wiring accessories



Reliable

100 percent MCB and RCD coordination, easy ordering and design, error free fast connections

Acti 9 | Advanced Communication Technology that Inspires.....

> Innovative

- Centralized control system including energy metering
- Large and variable data reading and computing through universal Modbus protocol

> Efficient

- One-click, prefabricated wiring for comprehensive communication between your distribution board or panel and any facility management system

> Reliable

- Error proof connection leading to reduction in downtime
- EMC tested for immunity, radiated and conducted safety

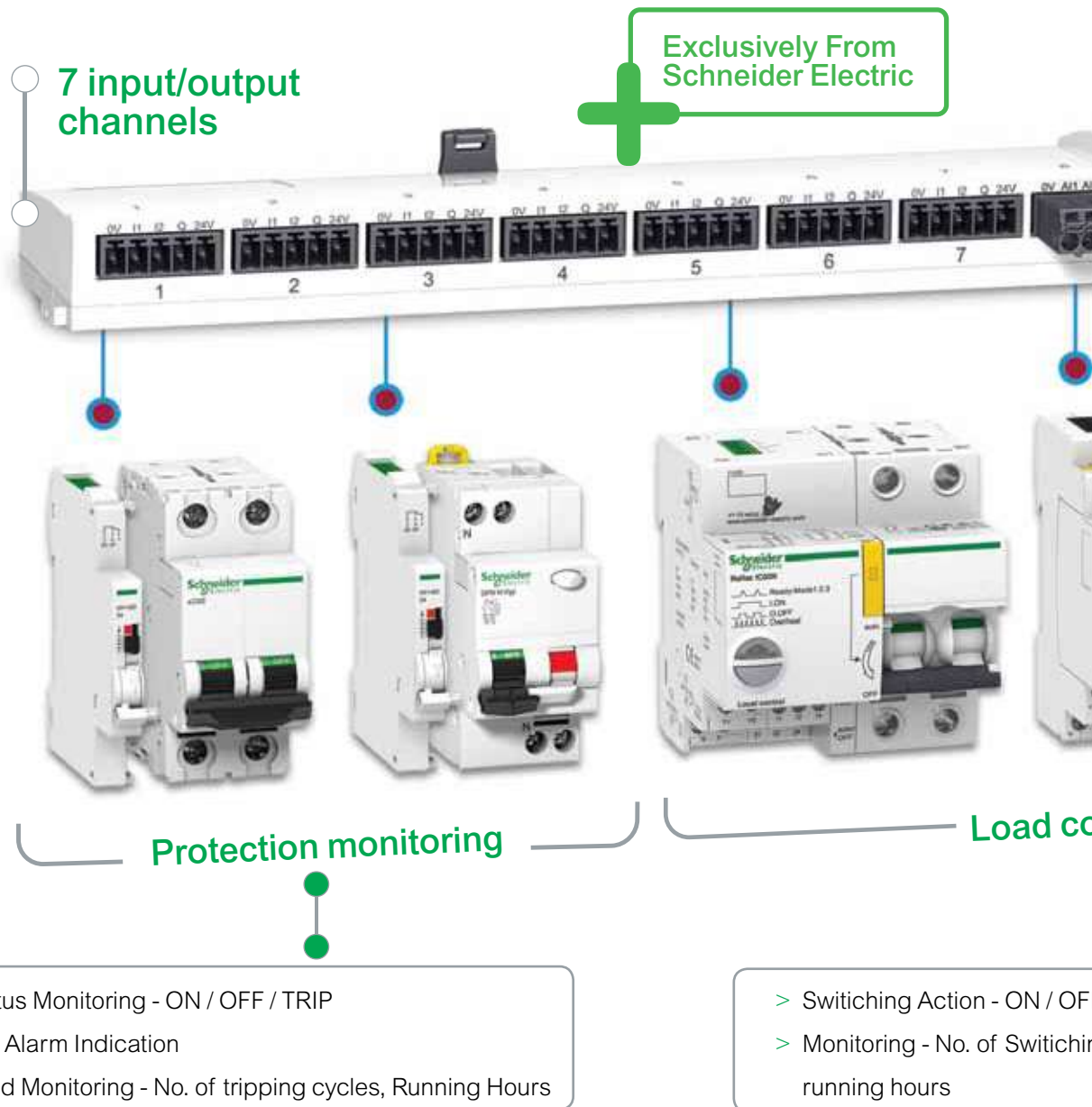

Meets the challenge of all your applications

Detailed load control, reduced downtime and accurately planned maintenance

Ready to connect to any facility management solution

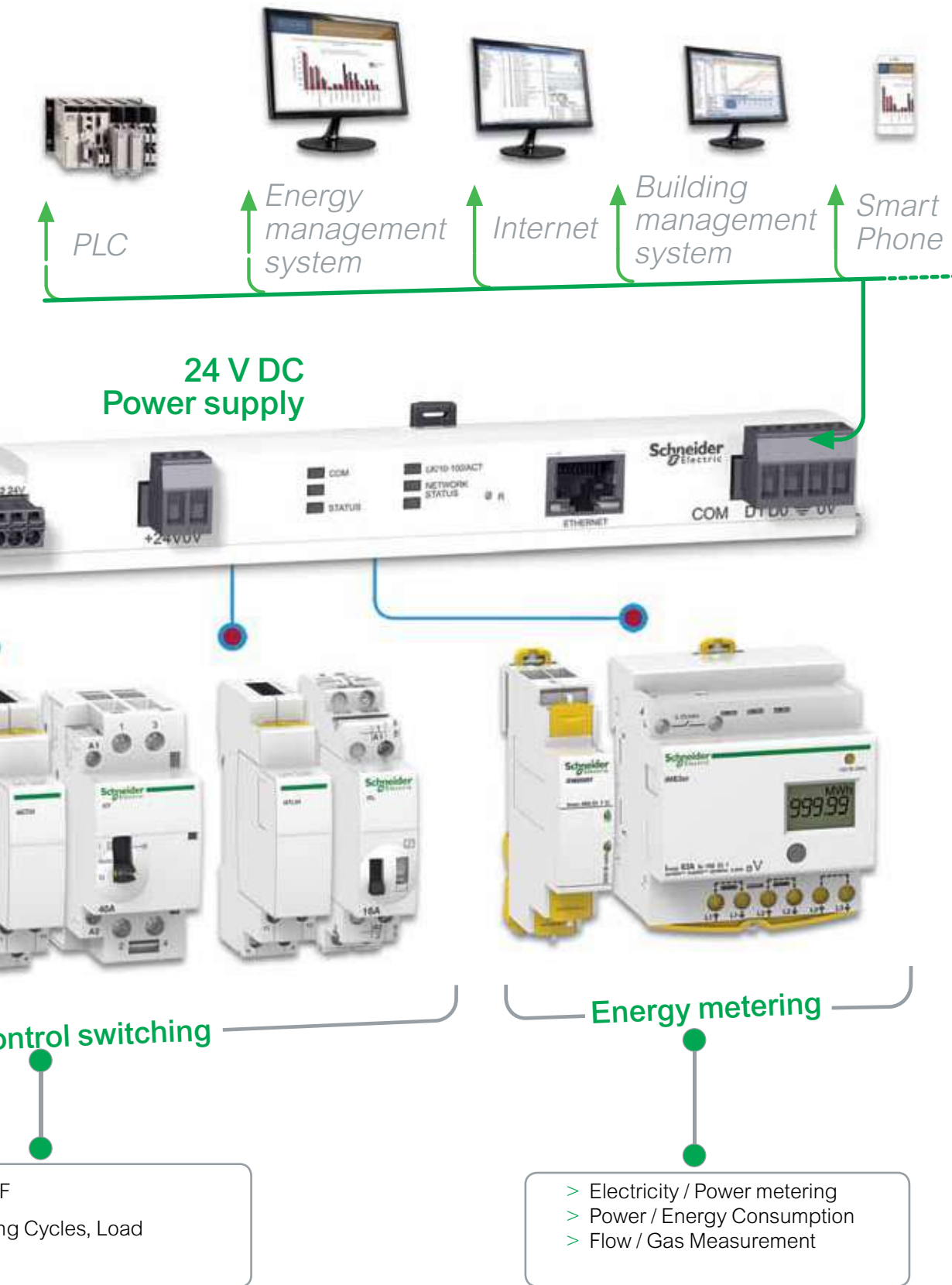

Environmental data program
REACH, RoHS, PEP, EOL compliant

AC Miniature Circuit Breakers - xC60 - IS/IEC 60898-1



- Breaking Capacity as per IEC 60898 and IS/IEC 60898-1, Icn = 10kA
- Can be used for DC application upto 60V per pole
- Higher Installation Life: Energy Limitation Class 3, Fast Closure Mechanism
- Ease, Speed and Flexibility of installation - Biconnect, Line-Load Reversible
- Field-fittable auxiliaries for advance protection and monitoring
- Positive Contact Indication for assurance of disconnection

[In] Rated Current (A)	1 Pole Reference	Unit MRP [₹]	2 Pole Reference	Unit MRP [₹]	3 Pole Reference	Unit MRP [₹]	4 Pole Reference	Unit MRP [₹]
Module Width**	1 mod		2 mod		3 mod		4 mod	
MOQ	12 Nos.		6 Nos.		4 Nos.		3 Nos.	
B curve								
6	A9N1P06BGN <input checked="" type="checkbox"/>	502	A9N2P06BGN <input checked="" type="checkbox"/>	1516	A9N3P06BGN <input checked="" type="checkbox"/>	2515	A9N4P06BGN	3212
10	A9N1P10BGN <input checked="" type="checkbox"/>	502	A9N2P10BGN <input checked="" type="checkbox"/>	1516	A9N3P10BGN <input checked="" type="checkbox"/>	2515	-	-
16	A9N1P16BGN <input checked="" type="checkbox"/>	502	A9N2P16BGN <input checked="" type="checkbox"/>	1516	A9N3P16BGN <input checked="" type="checkbox"/>	2515	A9N4P16BGN	3212
20	A9N1P20BGN <input checked="" type="checkbox"/>	502	A9N2P20BGN <input checked="" type="checkbox"/>	1516	A9N3P20BGN	2515	-	-
25	A9N1P25BGN <input checked="" type="checkbox"/>	502	-	-	A9N3P25BGN <input checked="" type="checkbox"/>	2515	-	-
32	A9N1P32BGN <input checked="" type="checkbox"/>	502	A9N2P32BGN	1516	A9N3P32BGN <input checked="" type="checkbox"/>	2515	A9N4P32BGN	3212
40	A9N1P40BGN <input checked="" type="checkbox"/>	1090	-	-	A9N3P40BGN	3432	A9N4P40BGN	4878
63	A9N1P63BGN <input checked="" type="checkbox"/>	1105	-	-	A9N3P63BGN <input checked="" type="checkbox"/>	3863	A9N4P63BGN	4923
C curve								
1	A9N1P01CGN <input checked="" type="checkbox"/>	770	A9N2P01CGN <input checked="" type="checkbox"/>	2089	A9N3P01CGN <input checked="" type="checkbox"/>	3313	A9N4P01CGN <input checked="" type="checkbox"/>	4169
2	A9N1P02CGN <input checked="" type="checkbox"/>	770	A9N2P02CGN	2099	A9N3P02CGN <input checked="" type="checkbox"/>	3313	A9N4P02CGN <input checked="" type="checkbox"/>	4169
3	A9N1P03CGN <input checked="" type="checkbox"/>	770	A9N2P03CGN <input checked="" type="checkbox"/>	2099	A9N3P03CGN <input checked="" type="checkbox"/>	3313	-	-
4	A9N1P04CGN <input checked="" type="checkbox"/>	770	A9N2P04CGN <input checked="" type="checkbox"/>	2099	A9N3P04CGN <input checked="" type="checkbox"/>	3313	A9N4P04CGN <input checked="" type="checkbox"/>	4169
6	A9N1P06CGN <input checked="" type="checkbox"/>	456	A9N2P06CGN <input checked="" type="checkbox"/>	1516	A9N3P06CGN <input checked="" type="checkbox"/>	2515	A9N4P06CGN <input checked="" type="checkbox"/>	3389
10	A9N1P10CGN <input checked="" type="checkbox"/>	456	A9N2P10CGN <input checked="" type="checkbox"/>	1516	A9N3P10CGN <input checked="" type="checkbox"/>	2515	A9N4P10CGN <input checked="" type="checkbox"/>	3389
16	A9N1P16CGN <input checked="" type="checkbox"/>	456	A9N2P16CGN <input checked="" type="checkbox"/>	1516	A9N3P16CGN <input checked="" type="checkbox"/>	2515	A9N4P16CGN <input checked="" type="checkbox"/>	3389
20	A9N1P20CGN <input checked="" type="checkbox"/>	456	A9N2P20CGN <input checked="" type="checkbox"/>	1516	A9N3P20CGN <input checked="" type="checkbox"/>	2515	A9N4P20CGN <input checked="" type="checkbox"/>	3389
25	A9N1P25CGN <input checked="" type="checkbox"/>	456	A9N2P25CGN <input checked="" type="checkbox"/>	1516	A9N3P25CGN <input checked="" type="checkbox"/>	2515	A9N4P25CGN <input checked="" type="checkbox"/>	3389
32	A9N1P32CGN <input checked="" type="checkbox"/>	456	A9N2P32CGN <input checked="" type="checkbox"/>	1516	A9N3P32CGN <input checked="" type="checkbox"/>	2515	A9N4P32CGN <input checked="" type="checkbox"/>	3389
40	A9N1P40CGN <input checked="" type="checkbox"/>	1090	A9N2P40CGN <input checked="" type="checkbox"/>	2440	A9N3P40CGN <input checked="" type="checkbox"/>	3830	A9N4P40CGN <input checked="" type="checkbox"/>	4923
50	A9N1P50CGN	1090	A9N2P50CGN	2440	A9N3P50CGN	3830	A9N4P50CGN	4923
63	A9N1P63CGN <input checked="" type="checkbox"/>	1105	A9N2P63CGN <input checked="" type="checkbox"/>	2461	A9N3P63CGN <input checked="" type="checkbox"/>	3957	A9N4P63CGN <input checked="" type="checkbox"/>	5127
D curve								
2	A9N1P02DGN <input checked="" type="checkbox"/>	777	A9N2P02DGN <input checked="" type="checkbox"/>	2121	-	-	-	-
3	A9N1P03DGN <input checked="" type="checkbox"/>	777	A9N2P03DGN	2121	A9N3P03DGN <input checked="" type="checkbox"/>	3363	-	-
4	A9N1P04DGN <input checked="" type="checkbox"/>	777	A9N2P04DGN <input checked="" type="checkbox"/>	2121	A9N3P04DGN <input checked="" type="checkbox"/>	3363	-	-
6	A9N1P06DGN <input checked="" type="checkbox"/>	655	A9N2P06DGN <input checked="" type="checkbox"/>	1589	A9N3P06DGN <input checked="" type="checkbox"/>	2649	-	-
10	A9N1P10DGN <input checked="" type="checkbox"/>	655	A9N2P10DGN <input checked="" type="checkbox"/>	1589	A9N3P10DGN <input checked="" type="checkbox"/>	2649	-	-
16	A9N1P16DGN <input checked="" type="checkbox"/>	655	A9N2P16DGN <input checked="" type="checkbox"/>	1589	A9N3P16DGN <input checked="" type="checkbox"/>	2649	A9N4P16DGN <input checked="" type="checkbox"/>	3514
20	A9N1P20DGN <input checked="" type="checkbox"/>	655	A9N2P20DGN <input checked="" type="checkbox"/>	1589	A9N3P20DGN <input checked="" type="checkbox"/>	2649	A9N4P20DGN <input checked="" type="checkbox"/>	3514
25	A9N1P25DGN <input checked="" type="checkbox"/>	655	A9N2P25DGN <input checked="" type="checkbox"/>	1589	A9N3P25DGN <input checked="" type="checkbox"/>	2649	A9N4P25DGN <input checked="" type="checkbox"/>	3514
32	A9N1P32DGN <input checked="" type="checkbox"/>	655	A9N2P32DGN <input checked="" type="checkbox"/>	1589	A9N3P32DGN <input checked="" type="checkbox"/>	2649	A9N4P32DGN <input checked="" type="checkbox"/>	3514
40	A9N1P40DGN <input checked="" type="checkbox"/>	1177	A9N2P40DGN <input checked="" type="checkbox"/>	2579	A9N3P40DGN <input checked="" type="checkbox"/>	4058	A9N4P40DGN <input checked="" type="checkbox"/>	5088
50	-	-	-	-	A9N3P50DGN	4058	-	-
63	A9N1P63DGN <input checked="" type="checkbox"/>	1191	A9N2P63DGN <input checked="" type="checkbox"/>	2610	A9N3P63DGN <input checked="" type="checkbox"/>	4094	A9N4P63DGN <input checked="" type="checkbox"/>	5141

Please contact Customer Care Center for Stockable and Non stockable status of references.

NORMAL STOCK ITEMS

W.E.F. January 15th, 2026

AC Miniature Circuit Breakers - XC60 - IEC - 60947-2



- Breaking Capacity as per IEC 60947-2, Icu = 15kA***
- Can be used for DC application upto 60V per pole
- Higher system performance with optimized cost: Cascading*
- Increased System Continuity: Discrimination*
- Higher Installation Life: Energy Limitation Class 3, Fast Closure Mechanism
- Ease, Speed and Flexibility of installation - Biconnect, Line-Load Reversible
- Field-fittable auxiliaries for advance protection and monitoring
- Positive Contact Indication for assurance of disconnection

[In] Rated Current (A)	1 Pole Reference	Unit MRP [₹]	2 Pole Reference	Unit MRP [₹]	3 Pole Reference	Unit MRP [₹]	4 Pole Reference	Unit MRP [₹]
Module Width**	1 mod		2 mod		3 mod		4 mod	
MOQ	12 Nos.		6 Nos.		4 Nos.		3 Nos.	
B curve								
6	A9N1P06BIN ✓	517	A9N2P06BIN ✓	1561	A9N3P06BIN ✓	2591	-	-
10	A9N1P10BIN ✓	517	A9N2P10BIN ✓	1561	A9N3P10BIN ✓	2591	-	-
16	A9N1P16BIN ✓	517	A9N2P16BIN ✓	1561	A9N3P16BIN ✓	2591	-	-
20	A9N1P20BIN ✓	517	A9N2P20BIN ✓	1561	-	-	-	-
25	A9N1P25BIN ✓	517	-	-	A9N3P25BIN ✓	2591	-	-
32	A9N1P32BIN ✓	517	-	-	A9N3P32BIN ✓	2591	A9N4P32BIN ✓	3491
40	A9N1P40BIN ✓	1123	-	-	-	-	A9N4P40BIN ✓	5024
63	A9N1P63BIN ✓	1138	-	-	A9N3P63BIN ✓	3979	A9N4P63BIN ✓	5071
C curve								
1	A9N1P01CIN ✓	793	A9N2P01CIN ✓	2162	A9N3P01CIN ✓	3412	A9N4P01CIN ✓	4294
2	A9N1P02CIN ✓	793	A9N2P02CIN ✓	2162	A9N3P02CIN ✓	3412	A9N4P02CIN ✓	4294
3	A9N1P03CIN ✓	793	A9N2P03CIN ✓	2162	A9N3P03CIN ✓	3412	-	-
4	A9N1P04CIN ✓	793	A9N2P04CIN ✓	2162	A9N3P04CIN ✓	3412	A9N4P04CIN ✓	4294
6	A9N1P06CIN ✓	470	A9N2P06CIN ✓	1561	A9N3P06CIN ✓	2591	A9N4P06CIN ✓	3491
10	A9N1P10CIN ✓	470	A9N2P10CIN ✓	1561	A9N3P10CIN ✓	2591	A9N4P10CIN ✓	3491
16	A9N1P16CIN ✓	470	A9N2P16CIN ✓	1561	A9N3P16CIN ✓	2591	A9N4P16CIN ✓	3491
20	A9N1P20CIN ✓	470	A9N2P20CIN ✓	1561	A9N3P20CIN ✓	2591	A9N4P20CIN ✓	3491
25	A9N1P25CIN ✓	470	A9N2P25CIN ✓	1561	A9N3P25CIN ✓	2591	A9N4P25CIN ✓	3491
32	A9N1P32CIN ✓	470	A9N2P32CIN ✓	1561	A9N3P32CIN ✓	2591	A9N4P32CIN ✓	3491
40	A9N1P40CIN ✓	1123	A9N2P40CIN ✓	2514	A9N3P40CIN ✓	3945	A9N4P40CIN ✓	5071
50	A9N1P50CIN	1123	A9N2P50CIN	2514	A9N3P50CIN	3945	A9N4P50CIN	5071
63	A9N1P63CIN ✓	1138	A9N2P63CIN ✓	2537	A9N3P63CIN ✓	4076	A9N4P63CIN ✓	5282
D curve								
2	A9N1P02DIN ✓	800	A9N2P02DIN ✓	2185	-	-	-	-
3	A9N1P03DIN ✓	800	-	-	A9N3P03DIN ✓	3465	-	-
4	A9N1P04DIN ✓	800	A9N2P04DIN ✓	2185	A9N3P04DIN ✓	3465	-	-
6	A9N1P06DIN ✓	675	A9N2P06DIN ✓	1638	A9N3P06DIN ✓	2730	-	-
10	A9N1P10DIN ✓	675	A9N2P10DIN ✓	1638	A9N3P10DIN ✓	2730	-	-
16	A9N1P16DIN ✓	675	A9N2P16DIN ✓	1638	A9N3P16DIN ✓	2730	A9N4P16DIN ✓	3620
20	A9N1P20DIN ✓	675	A9N2P20DIN ✓	1638	A9N3P20DIN ✓	2730	A9N4P20DIN ✓	3620
25	A9N1P25DIN ✓	675	A9N2P25DIN ✓	1638	A9N3P25DIN ✓	2730	A9N4P25DIN ✓	3620
32	A9N1P32DIN ✓	675	A9N2P32DIN ✓	1638	A9N3P32DIN ✓	2730	A9N4P32DIN ✓	3620
40	A9N1P40DIN ✓	1213	A9N2P40DIN ✓	2657	A9N3P40DIN ✓	4180	A9N4P40DIN ✓	5242
50	-	-	-	-	A9N3P50DIN	4180	A9N4P50DIN	5242
63	A9N1P63DIN	1226	A9N2P63DIN ✓	2689	A9N3P63DIN ✓	4217	A9N4P63DIN ✓	5295

***Coming Soon

Please contact Customer Care Center for Stockable and Non stockable status of references.

✓ NORMAL STOCK ITEMS

W.E.F. January 15th, 2026

DC Miniature Circuit Breakers - C60H



Suitable for
ComReady
Auxiliary



- Specially designed MCB for enhanced protection in DC installation
- Magnetic Arc Chutes to quick break DC current in event of fault
- Breaking capacity 6kA as per IEC 60947-2
- Voltage Rating: 1P - 250 V DC & 2P - 500 V DC
- Impulse Voltage: 6 kV
- Higher Installation Life: Energy Limiting Class: 3

[In] Rated Current (A)	Module Width 18mm/ module	1 Pole Reference	Unit MRP [₹]	Module Width 18mm/ module	2 Pole Reference	Unit MRP [₹]
MOQ		12 Nos.		6 Nos.		
C60H-DC						
0.5	1	A9N61500	1948	2	A9N61520	4278
1	1	A9N61501 <input checked="" type="checkbox"/>	1421	2	A9N61521 <input checked="" type="checkbox"/>	2932
2	1	A9N61502 <input checked="" type="checkbox"/>	1421	2	A9N61522 <input checked="" type="checkbox"/>	2932
3	1	A9N61503 <input checked="" type="checkbox"/>	1421	2	A9N61523 <input checked="" type="checkbox"/>	2932
4	1	A9N61504 <input checked="" type="checkbox"/>	1421	2	A9N61524 <input checked="" type="checkbox"/>	2932
5	1	A9N61505	1421	2	A9N61525	2932
6	1	A9N61506 <input checked="" type="checkbox"/>	1167	2	A9N61526 <input checked="" type="checkbox"/>	2386
10	1	A9N61508 <input checked="" type="checkbox"/>	1167	2	A9N61528 <input checked="" type="checkbox"/>	2386
16	1	A9N61511 <input checked="" type="checkbox"/>	1167	2	A9N61531 <input checked="" type="checkbox"/>	2386
20	1	A9N61512 <input checked="" type="checkbox"/>	1167	2	A9N61532 <input checked="" type="checkbox"/>	2386
25	1	A9N61513 <input checked="" type="checkbox"/>	1167	2	A9N61533 <input checked="" type="checkbox"/>	2386
32	1	A9N61515 <input checked="" type="checkbox"/>	1345	2	A9N61535 <input checked="" type="checkbox"/>	2386
40	1	A9N61517 <input checked="" type="checkbox"/>	1600	2	A9N61537 <input checked="" type="checkbox"/>	3518
50	1	A9N61518 <input checked="" type="checkbox"/>	1600	2	A9N61538 <input checked="" type="checkbox"/>	3518
63	1	A9N61519 <input checked="" type="checkbox"/>	1600	2	A9N61539 <input checked="" type="checkbox"/>	3518

Special application MCBs



Solar Application – PV DC

- DC MCB for multi string PV installations
- Operating Voltage: 800V DC
- Current Rating up to 25A
- Complies to IEC / EN 60947-2



Rail Application* (including Rolling Stock)

- Shock & vibration resistant (IEC 61373) – Cat 1, Class B
- Complies to EN 45545 HL2
- Complies to IEC / EN 60947-2



UL MCB

- Type: UL1077, UL489
- Breaking Capacity of 10kA
- Complies to IEC 60947-2 / UL1077 / UL489 / CSA

Note:

Please contact nearest Schneider Electric sales office or Customer Care for Reference and prices of Application Specific MCBs

*Rail Application RCDs are also available on demand **18mm/module

Residual Current Devices (RCDs) - For Human and Fire Protection



**30
mA**

Use of **30mA RCDs** is now **mandatory** for all **domestic intallations** in India (NEC 2023)



Schneider Electric provides voltage independent RCDs which work on current sensing technology and provide protection from residual current even at extra low voltages (down to zero volts) and in case of break of neutral.

**SI
Type**

Schneider Electric offers SI RCD built to operate in electrically polluted or installation in aggressive environments:

- Flourescent / Variable lighting with Electronic ballast
- Powerful IT / Telecom equipment / Air conditioning
- Severe Atmosphere - High lighting risk / Swimming pools

* for Measures relating to Safety and Electric supply

AC Residual Current Circuit Breakers - xID



- Complies to IEC/EN 61008-1 and IS 12640
- AC Type
- Selective range available for time based discrimination
- Easy Monitoring: Earth fault indication and Test Button on front face
- Operating temperature up to +70°C
- Mandatory to use OF-S auxiliary to add any indication or tripping auxiliary

[In] Rated Current (A)	Earth-Leakage Sensitivity (mA)	Module Width 18mm/module	2 Pole Reference	Unit MRP [₹]	Module Width 18mm/module	4 Pole Reference	Unit MRP [₹]
25	30	2	A9N16201	5158	4	A9N16251	7240
	100	2	A9N16203	5725	4	A9N16253	7694
	300	2	A9N16202	5899	4	A9N16252	7921
40	30	2	A9N16204	6072	4	A9N16254	7127
	100	2	A9N16205	6546	4	A9N16255	7737
	300	2	A9N16206	6866	4	A9N16256	8035
63	30	2	A9N16208	7312	4	A9N16258	8253
	100	2	A9N16209	7863	4	A9N16259	9141
	300	2	A9N16210	8021	4	A9N16260	9183
80	30	2	A9N16212	12291	4	A9N16261	14558
	100	2	A9N16213	12496	4	A9N16262	14793
	300	2	-	-	4	A9N16263	14872

AC Residual Current Circuit Breakers (RCCBs) - ID



- Complies to IEC 61008-1
- AC Type
- Degree of pollution: 3 (suitable for industrial environment)
- Electrical ON/OFF indication by using OFSP auxiliary

Poles Description	[In] Rated Current (A)	Earth-Leakage Sensitivity (mA)	Module Width 18mm/module	Reference	Unit MRP [₹]
4P	100	30	4	**A9R11491	On Request
		100	4	**A9R12491	On Request
	125	30	4	A9R11492	On Request
		100	4	A9R12492	On Request
		300	4	A9R14492	On Request

Note: **For 100A RCCB Auxiliary kindly contact Customer Care

AC Residual Current Breaker Overload (RCBO) - DPN N Vigi



- Complies to IEC/EN 61009
- AC Type Tripping characteristics - C curve
- Overvoltage category (IEC 60364): IV
- Suitable for indication & tripping auxiliaries

Poles Description	[In] Rated Current (A)	Earth-Leakage Sensitivity (mA)	Module Width 18mm/module	Reference	Unit MRP [₹]
1P+N	6	30	2	A9N19661	7964
		300	2	A9N19681	8089
	10	30	2	A9N19663	7964
		300	2	A9N19683	8089
	16	30	2	A9N19665	7964
		300	2	A9N19685	8089
	20	30	2	A9N19666	7964
		300	2	A9N19686	8089
	25	30	2	A9N19667	7964
		300	2	A9N19687	8089
	32	30	2	A9N19668	7964
		300	2	A9N19688	8492
	40	30	2	A9N19669	10076
		300	2	A9N19689	10251

Note: Application specific RCDs also available with 10mA, 500mA and 1000mA sensitivities

Please contact nearest Schneider Electric Sales Office or Customer Care Center for Reference and Prices

Please contact Customer Care Center for Stockable and Non stockable status of references.

SI Type Residual Current Circuit Breakers (RCCBs) - xID SI



- Complies to IEC/EN 61008-1
- SI RCDs offer enhanced immunity against Electrical Disturbances; Polluted and Corrosive environments - Guaranteed performance in harsh operating conditions
- Ensures continuity of supply in networks with:
 - Transient overvoltages
 - Loads generating HF leakage current i.e. harmonics
 - Loads generating continuous leakage current
- Ensures tripping on genuine earth fault in networks with:
 - Pulsating DC components
 - HF applications which "Blinds" (non-tripping) the conventional RCDs

[In] Rated Current (A)	Earth-Leakage Sensitivity (mA)	Module Width 18mm/module	2 Pole Reference	Unit MRP [₹]	Module Width 18mm/module	4 Pole Reference	Unit MRP [₹]
25	30	2	A9N16234	12000	4	A9N16321	13374
40	30	2	A9N16237	12604	4	A9N16324	13796
63	30	2	A9N16240	12966	4	A9N16327	14165
63	300	2	A9N16246	13064	4	-	-

Vigi Block for xC60 (Add-on RCD Module, 2 & 4 Pole)



- Flexibility to use MCB of any tripping curve to suit applications, ensuring best 3 in 1 protection
- No auxiliary supply required
- AC Class protection
- Degree of pollution: 3 (suitable for industrial environment)
- Immune to nuisance tripping due to transient over voltages

[In] Rated Current (A)	Earth-Leakage Sensitivity (mA)	Module Width 18mm/module	2 Pole Reference	Unit MRP [₹]	Module Width 18mm/module	4 Pole Reference	Unit MRP [₹]
25	30	1.5	A9N26581	9535	3	A9N26595	12032
	100	1.5	A9N26582	10495	3	A9N26596	10685
	300	1.5	A9N26583	11096	3	A9N26597	11500
63	30	2	A9N26611	11536	3.5	A9N26643	11579
	100	2	A9N26612	12217	3.5	A9N26644	12027
	300	2	-	-	3.5	A9N26645	12583

Note: Vigi Block for High Rating up to 125A (C120) and High Breaking Capacity (NG125) available on demand

SI Type Residual Current Breaker Overload (RCBO) - DPN N Vigi SI



- Complies to IEC/EN 61009
- Ensures continuity of supply in networks with:
 - Transient overvoltages
 - Loads generating HF leakage current i.e. harmonics
 - Loads generating continuous leakage current
- Ensures tripping on genuine earth fault in networks with :
 - Pulsating DC components
 - HF applications which "Blinds" (non-tripping) the conventional RCDs

Poles Description	[In] Rated Current (A)	Earth-Leakage Sensitivity (mA)	Module Width 18mm/module	Reference	Unit MRP [₹]
1P+N	6	30	2	A9N19631	15855
	10	30	2	A9N19632	15855
	16	30	2	A9N19634	15855
		300	2	A9N19644	15855
	25	30	2	A9N19636	15855
	32	30	2	A9N19637	15855
	40	30	2	A9N19638	18773
		300	2	A9N19648	20891

*For Prices, please contact nearest Schneider Electric Sales Office or Customer Care Center are Center for Reference and Prices

Please contact Customer Care Center for Stockable and Non stockable status of references.

NORMAL STOCK ITEMS

W.E.F. January 15th, 2026

Acti 9 Active AFDD

Make active safety your new standard

- Integrated arc fault protection for prevention against electrically ignited fires
- AFDD complies to IEC/EN 62606
- RCD complies to IEC/EN 61009-2-1
- Protection Against Series & Parallel Arc

Acti9 iCV40N VigiARC Active, 30 mA, A-SI type



- Ensures tripping on genuine earth fault in networks with :
 - Pulsating DC components
 - HF applications which "Blinds" (non-tripping) the conventional RCDs
- Available in C Curve Configuration

Poles Description	[In] Rated Current (A)	Earth-Leakage Sensitivity (mA)	Module Width 18mm/module	Reference	Unit LP [₹]
1P+N	6	30	2	A9TDNC606	On Request
	10	30	2	A9TDNC610	On Request
	16	30	2	A9TDNC616	On Request
	25	30	2	A9TDNC625	On Request
	32	30	2	A9TDNC632	On Request
	40	30	2	A9TDNC640	On Request

Acti9 iCV40H VigiARC Active, 30 mA, A-SI type



- Ensures tripping on genuine earth fault in networks with :
 - Pulsating DC components
 - HF applications which "Blinds" (non-tripping) the conventional RCDs
- Available in C Curve Configuration
- Seamless connectivity with Wiser 2.0 & ecostruxre through Panel server

Poles Description	[In] Rated Current (A)	Earth-Leakage Sensitivity (mA)	Module Width 18mm/module	Reference	Unit LP [₹]
1P+N	6	30	2	A9TDND606	On Request
	10	30	2	A9TDND610	On Request
	16	30	2	A9TDND616	On Request
	20	30	2	A9TDND620	On Request
	25	30	2	A9TDND625	On Request
	32	30	2	A9TDND632	On Request

Common Auxiliaries for xC60 / RCDs Range

- Field-fittable auxiliaries (clip fitted) mounted on left side with maximum width of 54mm
- Order: Tripping Auxiliaries (MN first) followed by Indication Auxiliaries (SD first)

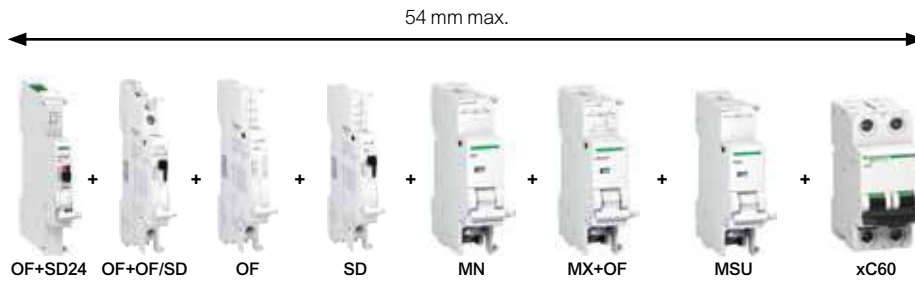

Type	Module Width 18mm/module	Reference	Unit MRP [₹]
Indication Auxiliaries			
Acti9 A9N iOF bottom wiring 0.1-6A aux	0.5	A9N26904	3413
Acti9 A9N SD bottom wiring 0.1-6A aux	0.5	A9N26907	1926
Acti9 A9N OF/SD+OF top/bt wir 0.1-6A aux	0.5	A9N26909	4905
Acti9 A9A iOF bottom wiring 0.1-6A aux	0.5	A9A26904	1701
Acti9 A9A iOF/SD+OF t&b wire 0.1-6A aux	0.5	A9A26909	5211
OF+SD24 auxiliary contact (ComReady)	0.5	A9N26899	4317
Protection Auxiliaries – Trip Indication on front face			
MN Under-voltage Release 220-240V AC		A9N26960	6937
MSU Over-voltage Release 275V AC	1	A9N26500	8214
Tripping Auxiliaries – Trip Indication on front face			
MX + OF Shunt Release 110-415V AC: for Remote tripping of Circuit Breaker	1	A9N26946	4512
MX + OF Shunt Release 12-24V AC/DC: for Remote tripping of Circuit Breaker		A9N26948	4512
Auxiliary Switch for RCCBs – Mandatory for use of Auxiliaries with RCCBs			
Auxiliary switch for RCCB up to 80A (OF-S)	0.5	A9N26923	7978
Auxiliary switch for RCCBs 125A (OFSP)	0.5	A9N16940	4052

Accessories



Type	Description	Reference	Unit MRP [₹]
Rotary Handle*	Breaker Switching Sub-Assembly	27046	7262
Rotary Handle*	Extended, Disconnectable handle	27047	3667
Padlock** (bag of 2)		26970	1551
Aluminum cable terminal**		27060	913
Spacer		A9N27062	361

* for xC60, C120, DPN N Vigi, C60H-DC, xSW - Multi poles only

Note:

For all above Reference MOQ = 1
Please contact Customer Care Center for Stockable and Non stockable status of references.

NORMAL STOCK ITEMS

W.E.F. January 15th, 2026

Protection Against Lightning Strikes And Switching Surges



For all low voltage switchboards and electrical enclosures:

Comprehensive range

- To ensure the protection of equipment connected to:
- Low voltage networks,
- Telecommunications networks,
- Computer networks.
- Easy to implement and use.
- Compatibility with all earthing systems (TT, TNS, TNC, IT).
- Technical and aesthetic consistency

Continuity of service and certified safety

Schneider Electric certified coordination between the surge arrester and its disconnection circuit breaker.

Compliance with standards: IEC/EN 61643-11.



More and more electrical equipment today is sensitive to overvoltages caused by lightning.



90%

of power outlets supply equipment incorporating electronic devices.



iQuick PRD “built-in” technology surge arresters, a Schneider Electric innovation, incorporate their own disconnection circuit breaker: easy to choose and simple to install for greater effectiveness.



Up to **30%** of installation time saved.

Surge Arresters - Type 1+ 2



- Complies to EN/IEC 61643 -11
- Withdraw able type: Easy Replacement
- Inbuilt SPD health Indicator: Also available with remote signaling
- For protection against Direct lightning surge, Indirect lightning surge, Switching surge
- Iimp up to 25kA & Imax upto 40kA
- **Always use a Back-up MCB with your SPD**
- Maximum Operating Voltage [Uc]: 350V

Type	Pole Description	Module Width 18mm/module	Reference	Unit MRP [₹]
PRD1 25r	1P	2	16329	24737
	1P + N	4	16330	44404
	3P	6	16331	69918
	3P + N	8	16332	86869

Surge Arresters iPRD - Type 2 (Withdrawable type) (TT, TN-S, TN-C Systems)



- Complies to IEC 61643-11/2011 T2 and EN 61643-11
- For protection against Indirect lightning surge and Switching surge
- Inbuilt health Indicator
- Response time < 25ns
- Imax (8/20 s): 65/40/15/8kA
- Maximum Operating Voltage [Uc]: 340V
- Level of protection, Up: 1.0 - 2.0 kV
- Remote indication contact with 8r/20r/40r/65r
- **Always use a Back-up MCB with your SPD**

Type	Rated Voltage (V)	Pole Description	Module Width 18mm/module	Reference	Unit MRP [₹]
iPRD8	230	1P	1	A9L08100	6060
	230	1P+N	2	A9L08500	11559
	230/400	3P	3	A9L08300	15601
	230/400	3P+N	4	A9L08600	23548
iPRD8r	230	1P+N	2	A9L08501	13857
	230/400	3P+N	4	A9L08601	28258
iPRD20	230	1P	1	A9L20100	6792
	230	1P+N	2	A9L20500	14530
	230/400	3P	3	A9L20300	18600
iPRD20r	230/400	3P+N	4	A9L20600	26297
	230	1P+N	2	A9L20501	17023
	230/400	3P+N	4	A9L20601	32156
iPRD40	230	1P	1	A9L40100	8432
	230	1P+N	2	A9L40500	16735
	230/400	3P	3	A9L40300	24021
iPRD40r	230/400	3P+N	4	A9L40600	33496
	230	1P	1	A9L40101	9441
	230	1P+N	2	A9L40501	21574
iPRD65r	230/400	3P	3	A9L40301	32327
	230/400	3P+N	4	A9L40601	40202
	230	1P	1	A9L65101	12621
iPRD65r	230	1P+N	2	A9L65501	27496
	230/400	3P	3	A9L65301	35881
	230/400	3P+N	4	A9L65601	46557

Spare Cartridges for iPRD



- Spare Cartridges for iPRD8r, iPRD20r, iPRD40r and iPRD65r
- End of life indication available on front face
- These Cartridges are not compatible with Old SPD range (A9L16...)**

Type	Spare Cartridges for	Reference	Unit MRP [₹]
iPRD 65-350	iPRD65r	A9L65102	7901
iPRD 40-350	iPRD40, iPRD40r	A9L40102	6383
iPRD 20-350	iPRD20, iPRD20r	A9L20102	4872
iPRD Neutral	All products (1P+N, 3P+N)	A9L00002	6524

**Spare Cartridges for Old SPD Range (A9L16...) are available on demand - please contact nearest Schneider Electric Sales Office or Customer Care for Reference and prices

Note:

For all above Reference MOQ = 1

Please contact Customer Care Center for Stockable and Non stockable status of references.

NORMAL STOCK ITEMS

W.E.F. January 15th, 2026

iQuick PRD - Type 2 with inbuilt MCB



- Compact SPD with in-built back up MCB - saving on space, MCB selection, wiring time
- Complies to EN/IEC 61643-11
- Withdrawable Type - Cost Efficient - Allows damaged Cartridges to be replaced without having to replace entire SPD
- Inbuilt SPD Health Indicator on front face of device; Remote signaling functionality also available
- Incoming Protection: iQuick PRD 40r (High Risk level) and iQuick PRD 20r (Moderate Risk level)
- Secondary Protection: iQuick PRD 8r is cascade mounted with incoming surge arresters

Type	Pole Description	Module Width 18mm/module	Reference	Unit MRP [₹]
iQuick PRD 8r	1P+N	4	A9L16298	17406
	3P	6.5	A9L16299	28149
	3P+N	7.5	A9L16300	35026
iQuick PRD 20r	1P+N	4	A9L16295	21461
	3P	6.5	A9L16296	33792
	3P+N	7.5	A9L16297	42032
Quick PRD 40r	1P+N	4	A9L16292	26843
	3P	6.5	A9L16293	40215
	3P+N	7.5	A9L16294	49979

Note: Spare / Replacement Cartridges available - For Reference and prices contact nearest sales office or customer care

Photovoltaic Surge Arresters



- Protection for photovoltaic panels and the DC input to the inverter from overvoltages due to a lightning strike
- Type 2 surge arresters
- Should be installed in switchboard inside the building. If switchboard is located outside, it must be weatherproof
- Withdrawable surge arrester allows damaged Cartridges to be replaced quickly
- Inbuilt SPD Health Indicator on front face of device; Remote signaling functionality also available

Type	U (cpv) Maximum Operating Voltage (V)	Module Width 18mm/module	Reference	Unit MRP [₹]
iPRD 40r	800	3	A9L40271	13235
	1000	3	A9L40281	16200

Note: Spare / Replacement Cartridges available - For Reference and prices contact nearest sales office or customer care

Surge Arresters for Communication Networks



- Analogue telephone line protection: iPRC surge arrester wired in series to the private installation input, protects the telephones, the modems (including ADSL) etc
- Protection for 2 low-current lines without common potential or 4 lines with common reference potential
- iPRI protects measuring instrument and PLC sensor inputs and the DC power supply inputs up to 53 V and AC power supply inputs up to 37 V

Type	[Ue] Operational Voltage (V)	Module Width 18mm/module	Reference	Unit MRP [₹]
PRI	48 V DC	1	A9L16339	23606
PRC	130 V AC	1	A9L16337	14152

Note:

For all above Reference MOQ = 1

Please contact Customer Care Center for Stockable and Non stockable status of references.

NORMAL STOCK ITEMS

W.E.F. January 15th, 2026

Isolator - xSW



- Complies to IEC/EN 60947-3
- Switching duty: AC - 22A
- Impulse Voltage
 - Upto 80 - 4kV
 - 100 & 125A - 6kV
- Rated short-time withstand current (Icw)
 - Upto 80A - 12.5In
 - 100 & 125A - 12 In for 1s

Poles Description	[In] Rated Current (A)	Module Width 18mm/module	MOQ	Reference	Unit MRP [₹]
2	40	2	6	A9S2P040	999
	63	2	6	A9S2P063	1320
3	40	3	4	A9S3P040	1745
	63	3	4	A9S3P063	2044
4	40	4	3	A9S4P040	2209
	63	4	3	A9S4P063	2406
	100	4	3	A9S4P100	4025
	125	4	3	A9S4P125	4448

Selector Switch - iSSW



- Complies to IEC 60947-5-1 and IEC 60669-1
- Rating 20A, 250V AC
- Electrical life (AC22): 30,000 cycles
- Connection: tunnel terminals cables up to 10 sq. mm

No. of positions	Poles Description	Contacts	Module Width 18mm/module	MOQ	Reference	Unit MRP [₹]
2	1	1 C/O	1	12	A9E18070	2137
	2	2 C/O	2	6	A9E18071	2938
	2	1NO + 1NC	1	12	A9E18072	1713
3	1	1 C/O	1	12	A9E18073	1961
	2	2 C/O	2	6	A9E18074	3545

iRO Buzzers



- Audible indication in housing and the tertiary sector
- Sound level of 70dBA at a distance of 60cm

Voltage	Module Width 18mm/module	Reference	Unit MRP [₹]
230V AC	1	A9A15322	2641

Please contact Customer Care Center for Stockable and Non stockable status of references.

NORMAL STOCK ITEMS

W.E.F. January 15th, 2026

ICT Contactors



Suitable for
ComReady
Auxiliary



- Complies to IEC 1095, E N 61095
- 4 operating modes switch on front face :
 - Automatic mode
 - Temporary "ON" mode
 - Permanent "ON" mode
 - Shutdown
- Mechanical contact position Indicator
- Safe installation maintenance: lock the contactor in ON position
- Silent operation (20dB) for entire range

Type	Rating (A)	No. of Contacts	Module Width 18mm/module	Reference	Unit MRP [₹]
1P	25	1NO	1	A9C20731	3164
	16	2NO	1	A9C22712	3256
2P	25	2NO	1	A9C20732	3967
	40	2NO	2	A9C20842	8383
	63	2NO	2	A9C20862	8511
3P	25	3NO	2	A9C20833	5017
	40	3NO	2	A9C20843	11137
	63	3NO	3	A9C20863	12104
4P	25	4NO	2	A9C20834	5253
	40	4NO	2	A9C20844	12972
	63	4NO	3	A9C20864	13686
	63	2NO + 2NC	3	A9C20868	15820

Note: 100A Contactor in 2P / 4P - available on request

iTL Impulse Relays



Suitable for
ComReady
Auxiliary



- Complies to IEC/EN 60669-2-2
- Safe maintenance: disconnection of remote control by selector switch
- Manual Controls on front face: 0-I toggle
- Mechanical contact position Indicator
- Maximum 5 operations/min. and 100 switching operations/day
- Degree of pollution: 3 (suitable for industrial environment)

Type	Rating (A)	Control Voltage	No. of Contacts	Module Width	Reference	Unit MRP [₹]
1P	16	230-240 VAC	1NO	1	A9C30811	2129
	32	230-240 VAC	1NO	1	A9C30831	2680
2P	16	230-240 VAC	2NO	1	A9C30812	3364
	32	230-240 VAC	2NO	1	A9C30831 + A9C32836	7746
3P	16	230-240 VAC	1NO+1NO/NC+1NO	2	A9C30811 + A9C32816	6193
	32	230-240 VAC	1NO+1NO/NC+1NO	2	A9C30831 + 2 x A9C32836	12812
4P	16	230-240 VAC	4NO	2	A9C30814	6503
	32	230-240 VAC	4NO	2	A9C30831 + 3 x A9C32836	17878

iIL Indicator Lights



- Complies to IEC 60947-5-1
- Indicator light with LED technology
- Service life 100,000 hours with constant luminous efficiency

Type	Colour	Module Width 18mm/module	Reference	Unit MRP [₹]
Single Indicator light	Red	1	A9E18320	2121
	Green	1	A9E18321	2121
	Blue	1	A9E18323	2121
	Orange	1	A9E18324	2121
3 phase voltage presence light	Red/Red/Red	1	A9E18327	6243
Single Push Button (1 NO+ 1NC)	Grey	1	A9E18033	2830

Note: For all above Reference MOQ = 1

Please contact Customer Care Center for Stockable and Non stockable status of references.

NORMAL STOCK ITEMS

W.E.F. January 15th, 2026

Communication Auxiliaries



Auxiliary for Protection Devices (OF+SD24)

Auxiliary for Contactors (iACT24)

Auxiliary for Impulse Relays (iATL24)

Description	Module Width	Reference	Unit MRP [₹]
OF+SD24	0.5	A9N26899	4317
iACT24	1	A9C15924	27914
iATL24	1	A9C15424	20910

Reflex iC60 - Integrated Control & Overcurrent Protection Device



- All in One Solution: MCB + Contactor + Impulse Relay + Auxiliary
- 10kA Breaking capacity as per IEC/EN 60947-2
- Ti24 interface: Connection to PLC, Smartlink
- 3 operating modes to cater to a variety of applications
- Safe lock down with Integrated Padlocking
- Simplified maintenance: Front face Indicator allows better reliability

[In] Rated Current (A)	2 Pole Reference	Unit MRP [₹]	3 Pole Reference	Unit MRP [₹]	4 Pole Reference	Unit MRP [₹]
Module Width **	4.5 mod		5.5 mod		6.5 mod	
B Curve						
10	A9C61210	54628	-	-	-	-
C Curve						
10	A9C62210	58003	A9C62310	62122	-	-
16	A9C62216	58003	A9C62316	59976	A9C62416	62411
25	A9C62225	55233	A9C62325	58794	-	-
40	A9C62240	58174	-	-	A9C62440	68231
63	-	-	-	-	A9C62463	70007

Note: **18mm/module

Please contact Customer Care Center for Stockable and Non stockable status of references.

NORMAL STOCK ITEMS

W.E.F. January 15th, 2026

Isobar Distribution System

EcoStruxure™ Innovation At Every Level

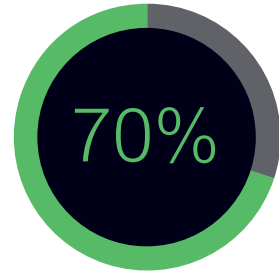

70%
of decision-makers
see the business
value of IoT*

*Schneider Electric IoT 2020
Business Report

From sensors to services, our Innovation At Every Level approach improves energy and operational efficiency by tapping the true business value of IoT advancements. We've made mobility, sensing, cloud, analytics, and cyber security technologies meaningful to customers, helping them compete in our IoT economy.

Connected Products:

The Internet of Things starts with the best things. Our IoT-enabled best-in-class connected products include breakers, drives, UPSs, relays, sensors, and more. Devices with embedded intelligence drive better decision-making throughout operations.

Edge Control:

Mission-critical scenarios can be unpredictable, so control of devices at the edge of the IoT network is a must. This essential capability provides real-time solutions that enable local control at the edge, protecting safety and uptime.

Applications, Analytics, and Services:

Interoperability is imperative to supporting the diverse hardware and systems in building, data center, industry, and Infrastructure end markets. EcoStruxure™ enables a breadth of agnostic applications, analytics, and services for seamless enterprise integration.

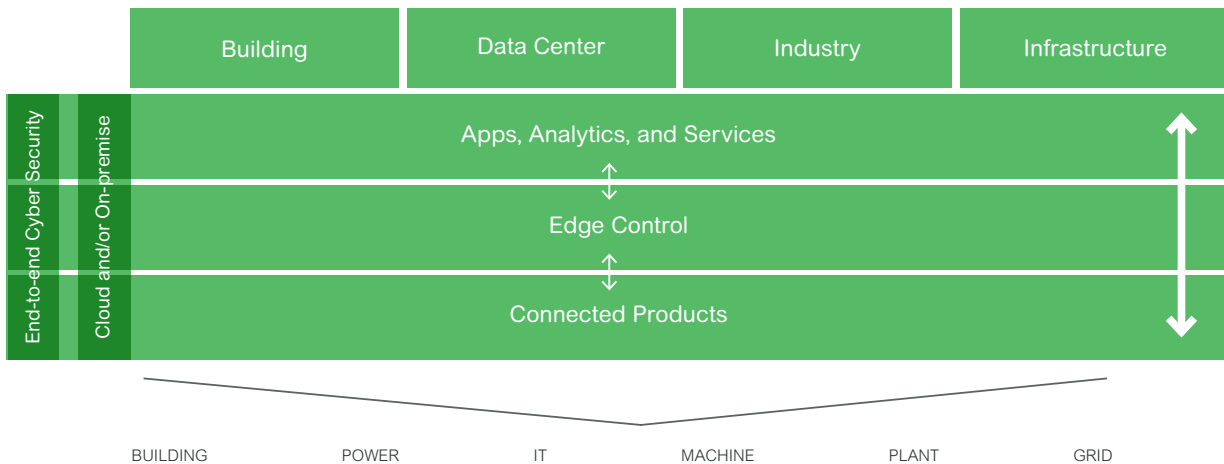

Connectivity built in

Acti9 Isobar harnesses the connectivity of the Acti9 range enabling distribution boards to become smart and connected.



1. **Enable asset management** on all outgoing ways with **PowerTag**



2. **Smartlink SiD** for wireless data concentration



3. **Enable further asset and energy management** through PowerTag for Compact NSX



4. **Monitor and control** your assets with SiB Smartlink



5. See the power and optimise the use of your assets with Facility Expert our **simple on-line services platform**



Acti 9

Isobar Pan Assembly

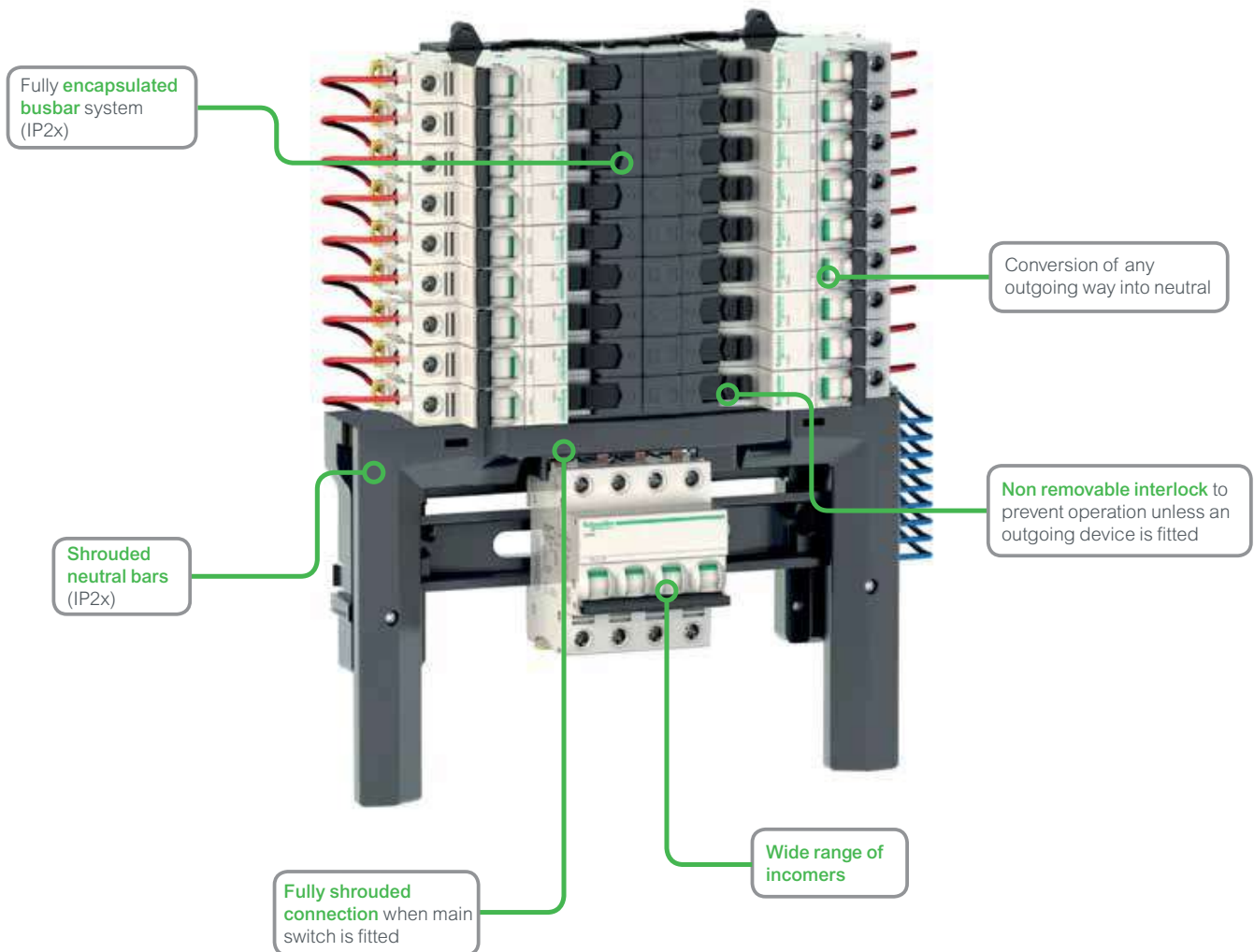

- Fully type tested conditional short circuit rating of 25kA to BS EN 61439-3
- 250A busbar rating
- Range of incomers: switch disconnectors, residual current devices, terminal blocks, MCCB
- Full range of device accessories and auxiliaries
- Shrouded Neutral
- Isobar disconnection conforms to BS/EN 60947-3 ensuring complete isolation for unused poles Option to switch any outgoing to neutral using distributed neutral kit

Description	Double Door Metal (IP43) Reference	Unit LP [₹]
Acti9 Isobar B - pan assembly - 16 ways TP + earth + neutral	SEA9BN16PEV	On Request
Acti9 Isobar B - pan assembly - 18 ways TP + earth + neutral	SEA9BN18PEV	On Request
Acti9 Isobar B - pan assembly - 24 ways TP + earth + neutral	SEA9BN24PEV	On Request
Acti 9 - 1P blank terminal block (no electrical connection)	SEA9BP	On Request
Isobar B - neutral bar - 1N - for distribution board - 16 ways	SEA9NB16	On Request
Isobar B - neutral bar - 1N - for distribution board - 18 ways	SEA9NB18	On Request
Isobar B - neutral bar - 1N - for distribution board - 24 ways	SEA9NB24	On Request
Isobar A - neutral bar - 1N - for distribution board - 4 ways SP+N	SEA9NKIT	On Request
Acti 9 - terminal block - 250A	SEA9NPB250TB	On Request
Acti 9 Isobar B - MCCB/Interpact connection kit	SEA9BINCKIT	On Request

*Price on Request

Please contact Schneider Electric Customer Care Center for Prices

Acti 9

Distribution Boards

Spectacular Design

Blends seamlessly with interiors



Unique Rounded Corners | Color - RAL 9003 white | Designer Rotary Knob

Maximized Wiring Space

Convenient and Safe wiring



Side mounted N-bar and E-bar



Removed all injurious sharp corners



15% more wiring area | Reduced U-box Collar | Removable Frame, Centre plate & Gland plate

Adaptable

Total Flexibility for ease of installation and usage

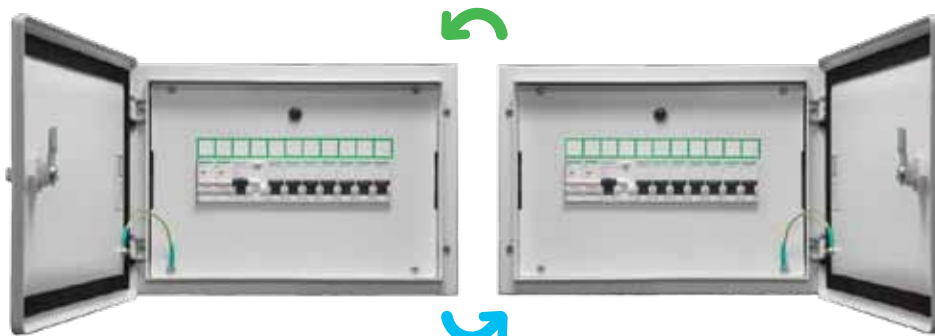

Unique 5 holes mounting with positioning hole



Surface and Flush installation | Field fittable key lock provision | Reversible Door

Inspiring the **S.M.A.R.T.** choice!!!

Robust Architecture

Perfect blend of Strength & Weight



High Strength-to-Weight ratio | RoHS and REACH Compliance – ideal solution for GREEN Buildings

Base Material used - Galvanized Iron

4X Rust Resistance

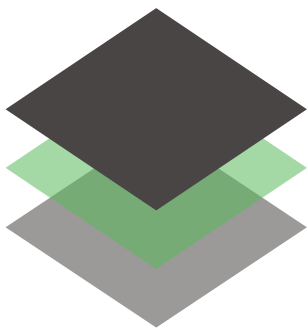

1. Powder Coating
- 2. Galvanized Iron**
3. Base Iron

Galvanized Iron | Gives 4X rust resistance
No Rusting | Even if the powder coating is scratched
No Propagation Of Rust | Even If base material is chipped off
No Hassle | of repainting due to rusting

Inspiring the **S.M.A.R.T.** choice!!!

Technically Proven

Safety Guaranteed



Designed and Manufactured as per **IS 8623 - 1 & 3** | IP and IK test by ERDA & CPRI | Glow wire tested

Type Tested as per IEC 61439 - 1 & 3



IEC 61439 - 3* Fully Compliant

*Tested at **NABL** and **ASTA** accredited testing facility



Salt Spray



IP43



IK09



Reliable Door



Earthing



Temp@
Max Curr

Mechanical Tests

Electrical Tests

W.E.F. January 15th, 2026

Acti 9

Distribution Boards

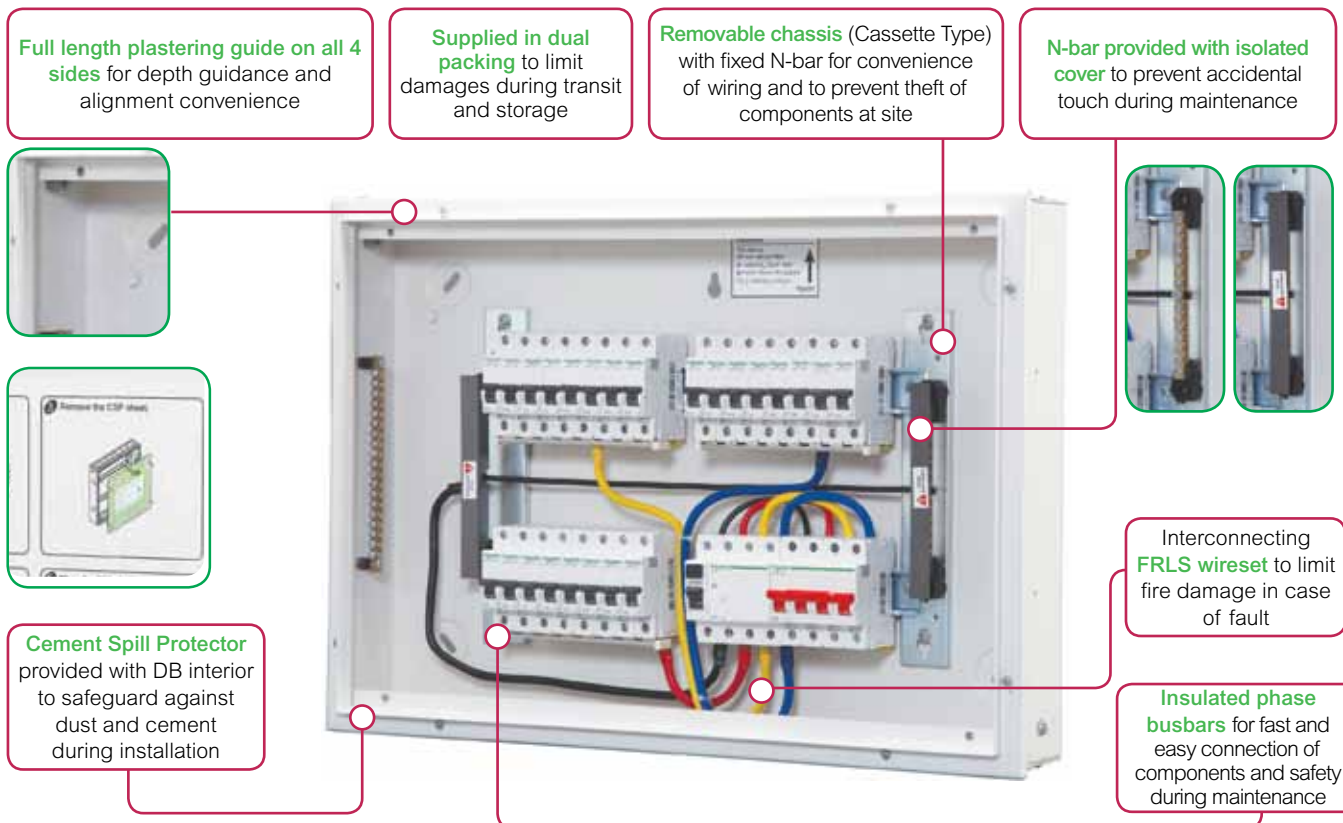
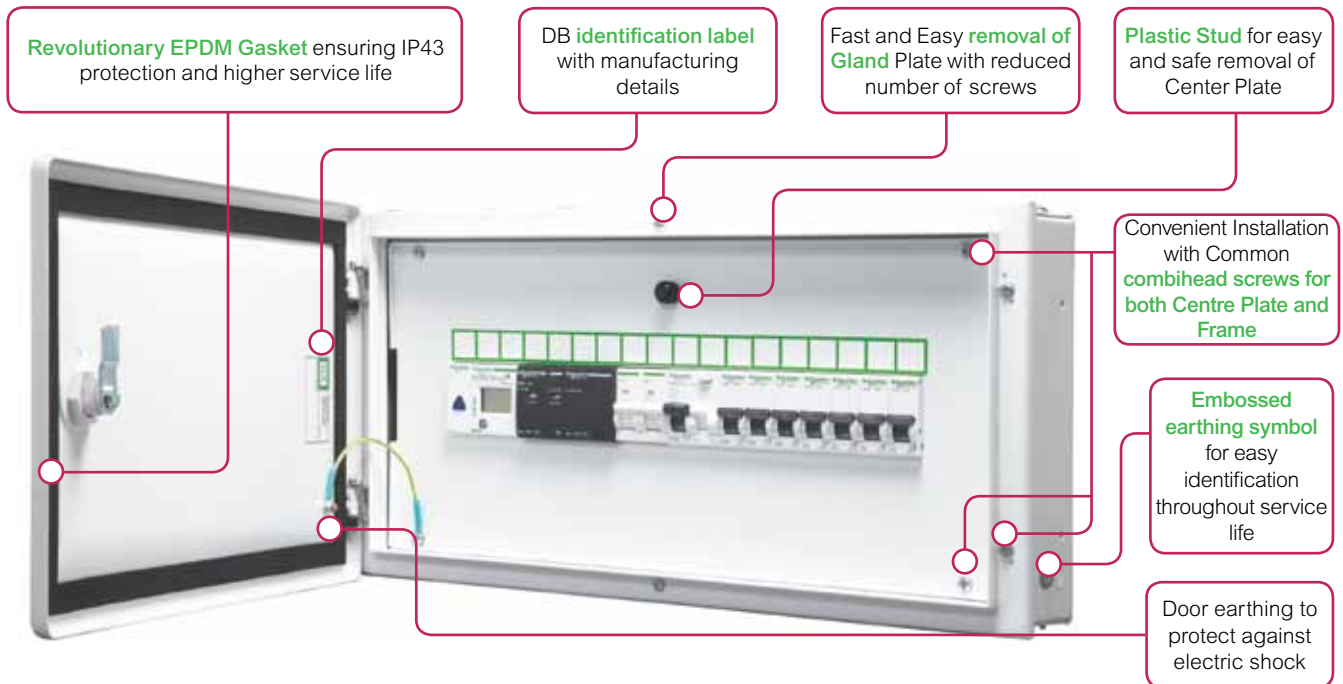

Metal Enclosures



- Metal Enclosure to mount individual Modular Device feeding directly to the load or final distribution board

Description	Total Module Cutout	Single Door (IP30) Reference	Unit MRP [₹]
2 way	1 / 2	A9HMES02 <input checked="" type="checkbox"/>	1152
4 way	3 / 4	A9HMES04 <input checked="" type="checkbox"/>	1152

SPN DBs



- SPN DB for distribution of Single Phase Neutral supply to respective load MCBs
- Incomer - DP RCCB/RCBO/Isolator/MCB
- Outgoing - SP MCBs

Description	Total Module Cutout (Incomer + Outgoing)	Single Door (IP30) Reference	Unit MRP [₹]	Double Door Metal (IP43) Reference	Unit MRP [₹]
6 way	6	A9HSNS06	2231	A9HSND06 <input checked="" type="checkbox"/>	3205
8 way	8	A9HSNS08 <input checked="" type="checkbox"/>	2646	A9HSND08 <input checked="" type="checkbox"/>	3493
12 way	12	A9HSNS12	3131	A9HSND12 <input checked="" type="checkbox"/>	4201
18 way	18	-	-	A9HSND18 <input checked="" type="checkbox"/>	5628

TPN DBs



- Standard TPN DBs for distribution of Three Phase and Neutral supply
- Incomer - FP RCCB/RCBO/Isolator/MCB
- Outgoing - SP MCBs

Description	Total Module Cutout (Incomer + Outgoing)	Single Door (IP30) Reference	Unit MRP [₹]	Double Door Metal (IP43) Reference	Unit MRP [₹]
4 way eco	4 + 12	-	-	A9HTND04E <input checked="" type="checkbox"/>	8362
4 way	8 + 12	-	-	A9HTND04 <input checked="" type="checkbox"/>	8434
6 way	8 + 18	-	-	A9HTND06 <input checked="" type="checkbox"/>	8560
8 way	8 + 24	-	-	A9HTND08 <input checked="" type="checkbox"/>	10555
12 way	8 + 36	-	-	A9HTND12 <input checked="" type="checkbox"/>	16114

Flexi Tier DBs



- Flexi DBs give total flexibility to mount any type and size of Modular devices as per load requirement
- Provided with N-Bar and E-Bar
- Flexi Tier DBs can be converted to PPI DB using 'PPI Kit' provided on next page

Description	Total Module Cutout (Incomer + Outgoing)	Single Door (IP30) Reference	Unit MRP [₹]	Double Door Metal (IP43) Reference	Unit MRP [₹]
2 Tier 24 Modules	2 x 12	-	-	A9HFD224	9038
3 Tier 36 Modules	3 x 12	-	-	A9HFD336	10855
4 Tier 40 Modules	4 x 10	-	-	A9HFD440 <input checked="" type="checkbox"/>	11468
4 Tier 56 Modules	4 x 14	-	-	A9HFD456 <input checked="" type="checkbox"/>	11986

Note:

For all above Reference MOQ = 1
Please contact Customer Care Center for Stockable and Non stockable status of references.

NORMAL STOCK ITEMS

W.E.F. January 15th, 2026

Acti 9

Distribution Boards

New Phase Segregated DBs

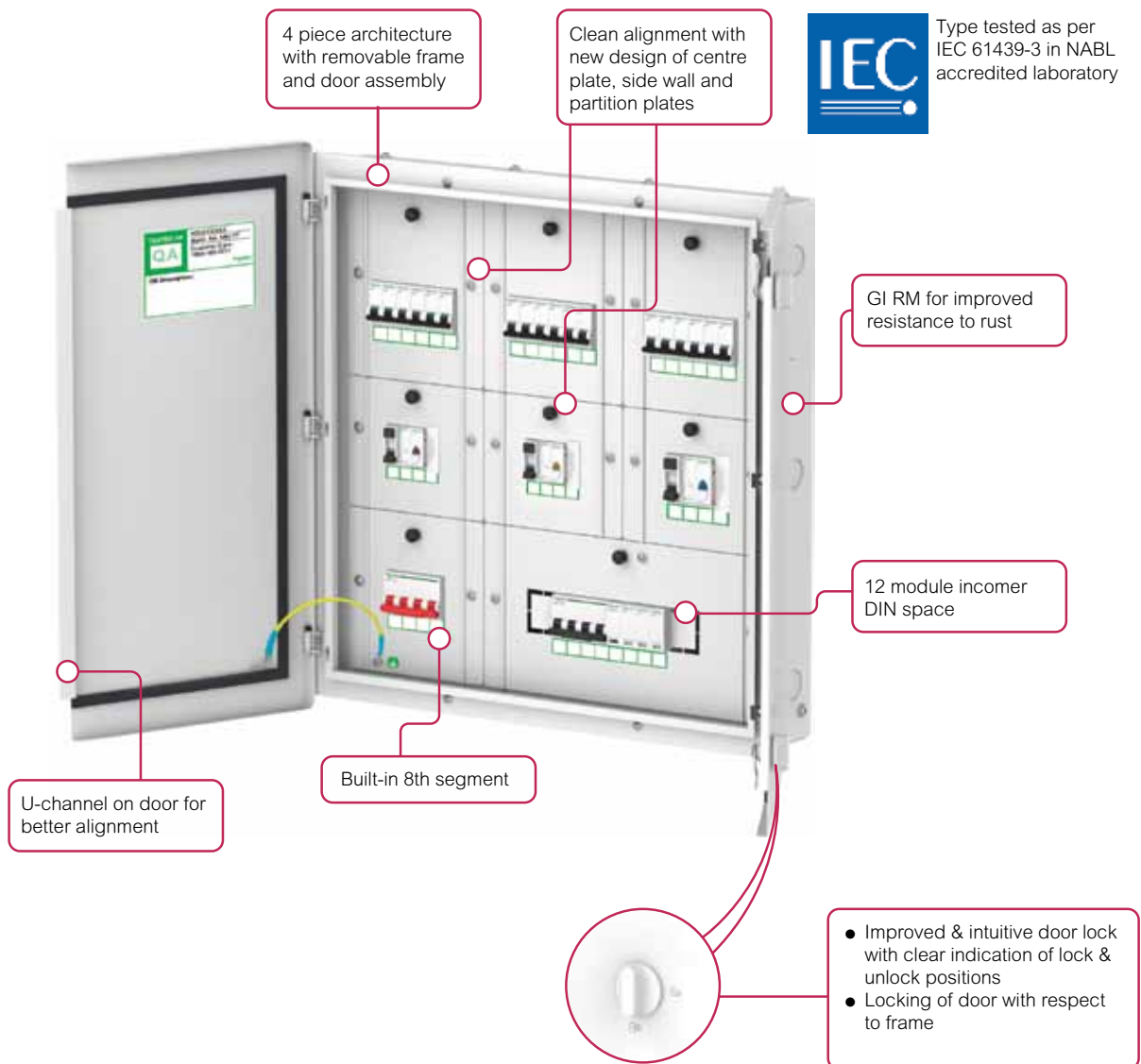

Key highlights

- 1 New compact design
- 2 Robust architecture
- 3 Type-tested system
- 4 4 piece construction
- 5 Built-in 8th segment
- 6 Split door for all variants
- 7 Clean alignment of doors, centerplates
- 8 Improved door locking
- 9 High rust resistance with GI
- 10 Increased incomer DIN space

Per Phase Isolation DBs

- PPI DBs to mount DP Residual Current Device (RCD) at an individual phase level to isolate the faulty phase in case of earth leakage and ensure continuity of supply to other healthy phases
- Incomer - Modular (FP MCB/Isolator) MCCB100A (TP/FP Compact NSX or EasyPact CVS)
- Sub-Incomer - DP RCCB/RCBO
- Outgoing - SP MCBs

PPI TPN DB



Description	Total Module Cutout (no. of rows x No. of modules per row)	Double Door Metal (IP43)	No of Ways	Unit MRP [₹]
6 Way TPN PPI DB	8 + 2 x 3 + 4 x 3	A9HTPI06	6 Ways	11132
8 Way TPN PPI DB	8 + 2 x 3 + 6 x 3	A9HTPI08	8 Ways	12912
12 Way TPN PPI DB	8 + 2 x 3 + 10 x 3	A9HTPI12	12 Ways	17764

PPI Flexi Tier DB

Description	Total Module Cutout (no. of rows x No. of modules per row)	Double Door Metal (IP43)	No of Ways	Unit MRP [₹]
4T40M Flexi PPI DB	4 x 10	A9HFP110	10	17238
4T56M Flexi PPI DB	4 x 14	A9HFP114	14	19409

Phase Segregated DBs



- Phase Segregated DBs to provide total safety for installer and maintenance personnel, by compartmentalizing each Phase and separating Incomer, Sub-Incomer and Outgoing
- Offers better continuity of supply in case of faults during maintenance at DB level.
- Incomer - Modular (FP MCB/Isolator) / MCCB 100A (TP/FP during maintenance Compact NSX or EasyPact CVS)
- Sub-Incomer - DP RCCB/RCBO
- Outgoing - SP MCBs
- GI sheet ensures improved rust resistance
- Type-tested system conforming IEC 61439-3
- Built-in 8th segment (for modular incomer only)
- Increased incomer DIN space of 12M for 6 ways to 12 ways
- Split door for all variants
- New design ensures clean alignment of doors, centerplates
- 4 piece architecture with removable frame
- Improved, intuitive door lock design with clear indication of lock and unlock positions

Description	Total Module Cutout (Additional segment + Incomer + Sub-incomer + Outgoing)	Double Door Metal (IP43) Reference	Unit MRP [₹]
4 way	4 + 8 + (3*4) + (3*4)	A9HPSG04	16789
6 way	4 + 12 + (3*4) + (3*6)	A9HPSG06	18772
8 way	4 + 12 + (3*4) + (3*8)	A9HPSG08	20961
12 way	4 + 12 + (3*4) + (3*12)	A9HPSG12	26312
12 way with MCCB I/c	0 + 100A MCCB + (3*4) + (3*12)	A9HPSG12M	35505

Note:

For all above Reference MOQ = 1
Please contact Customer Care Center for Stockable and Non stockable status of references.

VTPN DBs for Modular Incomer



- Ideal solution to distribute power supply to both 3 Phase and 1 Phase loads in the same DB
- Incomer - FP RCCB / RCBO / Isolator / MCB
- Outgoing - SP MCBs / TP MCBs
- 65% more Incomer Wiring Space.
- New Compact Fishbone with better Thermal Performance
- Short Circuit Withstand – 17 kA for 250mS (100 A)/ 25 kA (250 A) for 500mS
- Secure Connections with Fixed Spreader links
- IP 2X protection at Incomer with new shrouds
- Type tested as per IEC 61439 – 3 in NABL accredited Lab
- Knockout size for Incomer increased to 50mm (to accommodate Aluminium Cable)

Description	Total Module Cutout (Incomer + Outgoing)	Double Door Metal (IP43) Reference	No of Ways	Unit MRP [₹]
Acti9 VTPN DB 4 Ways Modular i-c 63A	12 + 12	A9HVM04	4 Ways	16336
Acti9 VTPN DB 8 Ways Modular i-c 63A	12 + 24	A9HVM08	8 Ways	20789
Acti9 VTPN DB 12 Ways Modular i-c 63A	12 + 36	A9HVM12	12 Ways	27811

VTPN DBs for MCCB Incomer



- DBs for higher incoming current distribution up to 250A
- Incomer - TP/FP Compact NSX or EasyPact CVS MCCB up to 250A
- Outgoing - SP MCBs / TP MCBs
- 65% more Incomer Wiring Space.
- New Compact Fishbone with better Thermal Performance
- Short Circuit Withstand – 17 kA for 250mS (100 A)/ 25 kA (250 A) for 500mS
- Secure Connections with Fixed Spreader links
- IP 2X protection at Incomer with new shrouds
- Type tested as per IEC 61439 – 3 in NABL accredited Lab
- Knockout size for Incomer increased to 50mm (to accommodate Aluminium Cable)

Description	Total Module Cutout (Incomer + Outgoing)	Double Door Metal (IP43) Reference	No of Ways	Unit MRP [₹]
Acti9 VTPN DB 4 Ways MCCB i-c 100A	100 A MCCB + 12	A9HVN04L	4 Ways	17889
Acti9 VTPN DB 4 Ways MCCB i-c 160A	160 A MCCB + 12	A9HVN04M	4 Ways	19695
Acti9 VTPN DB 8 Ways MCCB i-c 100A	100 A MCCB + 24	A9HVN08L	8 Ways	22673
Acti9 VTPN DB 8 Ways MCCB i-c 160A	160 A MCCB + 24	A9HVN08M	8 Ways	24535
Acti9 VTPN DB 8 Ways MCCB i-c 250A	250 A MCCB + 24	A9HVN08H	8 Ways	31453
Acti9 VTPN DB 12 Ways MCCB i-c 100A	100 A MCCB + 36	A9HVN12L	12 Ways	30140
Acti9 VTPN DB 12 Ways MCCB i-c 160A	160 A MCCB + 36	A9HVN12M	12 Ways	32742
Acti9 VTPN DB 12 Ways MCCB i-c 250A	250 A MCCB + 36	A9HVN12H	12 Ways	37207

Mivan Compatible DB

SPN DBs

Description	Total Module Cutout (Incomer + Outgoing)	Double Door Metal (IP43) Reference	No of Ways	Unit MRP [₹]
Acti9 DB 6 way SPN DD 1.6mm	2 + 4	A9HSND06Z	6 Ways	On Request
Acti9 DB 8 way SPN DD 1.6mm	2 + 6	A9HSND08Z	8 Ways	On Request
Acti9 DB 12 way SPN DD 1.6mm	2 + 10	A9HSND12Z	12 Ways	On Request
Acti9 DB 18 way SPN DD 1.6mm	2 + 16	A9HSND18Z	18 Ways	On Request

TPN DBs

Description	Total Module Cutout (Incomer + Outgoing)	Double Door Metal (IP43) Reference	No of Ways	Unit MRP [₹]
Acti9 DB 4 way TPN DD 1.6mm	8 + 4 x 3	A9HTND04Z	4 Ways	On Request
Acti9 DB 6 way TPN DD 1.6mm	8 + 6 x 3	A9HTND06Z	6 Ways	On Request
Acti9 DB 8 way TPN DD 1.6mm	8 + 8 x 3	A9HTND08Z	8 Ways	On Request
Acti9 DB 12 way TPN DD 1.6mm	8 + 12 x 3	A9HTND12Z	12 Ways	On Request

Please contact Customer Care Center for Stockable and Non stockable status of references.

NORMAL STOCK ITEMS

W.E.F. January 15th, 2026

Phase Segregated DBs (Mivan Compatible)

Description	Total Module Cutout (Additional segment + Incomer + Sub-incomer + Outgoing)	Double Door Metal (IP43) Reference	No of Ways	Unit MRP [₹]
Acti9 DB 4 way PSG DD 1.6mm	4 + 8 + (3*4) + (3*4)	A9HPSG04Z	4 ways	On Request
Acti9 DB 6 way PSG DD 1.6mm	4 + 12 + (3*4) + (3*6)	A9HPSG06Z	6 ways	On Request
Acti9 DB 8 way PSG DD 1.6mm	4 + 12 + (3*4) + (3*8)	A9HPSG08Z	8 ways	On Request
Acti9 DB 12 way PSG DD 1.6mm	4 + 12 + (3*4) + (3*12)	A9HPSG12Z	12 ways	On Request

Flexi Tier DBs (Mivan Compatible)

Description	Total Module Cutout (no. of rows x No. of modules per row)	Double Door Metal (IP43) Reference	No of Modules Per Row	Unit MRP [₹]
4 Tier 40 Modules	4 x 10	A9HFD440Z	10	On Request
4 Tier 56 Modules	4 x 14	A9HFD456Z	14	On Request

TV TEL DB

Description	Double Door Metal (IP30) Reference	Unit MRP [₹]
Acti9 DB TVTEL BOX 1mm IP30	A9HTVTEL	On Request
Acti9 DB TVTEL & ONT BOX 1.2MM IP30	A9HOTVTEL	On Request

Note: For all above Reference MOQ = 1

Metal Clad P&S Units

- Plug & Socket Unit with Electra Plug & Socket and provision to mount modular protection devices to feed the end load directly

Description	Total Module Cutout	Single Door (IP30) Reference	Unit MRP [₹]
10A 1P+N+E P&S	2	A9HMS210	2932
20A 1P+N+E P&S	2	A9HMS220	3137
30A 3P+E P&S	3	A9HMS330	6868

Please contact Customer Care Center for Stockable and Non stockable status of references.

NORMAL STOCK ITEMS

W.E.F. January 15th, 2026

Industrial P&S Units (provision to mount PratiKa Sockets)



- Plug & Socket Unit with provision to mount PratiKa straight / angled* socket and modular protection devices to feed the end load directly

Description	Total Module Cutout	Single Door (IP30) Reference	Unit MRP [₹]
16A 3P PK P&S	2	A9HKS316	2711
32A 3P PK P&S	2	A9HKS332	4478
32A 5P PK P&S	4	A9HKS532	5303
63A 5P PK P&S	4	A9HKS563	10708

Locks for Acti 9 DBs

Key Lock*



Lock & Unlock symbol on door for easy & intuitive operation

Description	Reference	Unit MRP [₹]
New Rotary Lock**	A9HRL901	873
New Key Lock**	A9HRL902	813

Note: **Use New Rotary lock reference A9HRL901 for:
Acti9 DBs manufactured September 2020 onwards
Acti9 DBs with lock & unlock symbol on door.

Please contact Customer Care Center for Stockable and Non stockable status of references.

NORMAL STOCK ITEMS

W.E.F. January 15th, 2026

Accessories for Distribution Boards

Wire Way Box for Double Door IP43 DBs

Description	Reference	Unit MRP [₹]
Wire way box for A9HSND06	A9HSND06WB	2158
Wire way box for A9HSND08	A9HSND08WB	2608
Wire way box for A9HSND12	A9HSND12WB	2908
Wire way box for A9HSND18	A9HSND18WB	4153
Wire way BOX FOR A9HTND04E	A9HTND04EWB	2997
Wire way box for A9HTND04	A9HTND04WB	3314
Wire way box for A9HTND06	A9HTND06WB	3514
Wire way box for A9HTND08	A9HTND08WB	4153
Wire way box for A9HTND12	A9HTND12WB	4851
Wire way BOX FOR A9HFD224	A9HFD224WB	3090
Wire way BOX FOR A9HFD336	A9HFD336WB	3059
Wire way BOX FOR A9HFD440	A9HFD440WB	2957
Wire way BOX FOR A9HFD456	A9HFD456WB	3314
WWB Acti9 PSG DB 8 Seg 4 Ways MCB i/c	A9HPSG04WWB	4275
WWB Acti9 PSG DB 8 Seg 6 Ways MCB i/c	A9HPSG06WWB	5002
WWB Acti9 PSG DB 8 Seg 8 Ways MCB i/c	A9HPSG08WWB	5596
WWB Acti9 PSG DB 8 Seg 12 Ways MCB i/c	A9HPSG12WWB	7253
WWB Acti9 PSG DB 7 Seg 12 Ways MCCB i/c	A9HPSG12MWWB	7747
WWB for Std VTPN DB MCB i/c	A9HVMXXWB	3144
WWB for Std VTPN DB MCCB i/c	A9HVNXXWB	3347

Modular Distribution Boards - Metallic

Description	Reference	Unit MRP [₹]
Busbars		
Fork Busbar 1P 12MOD. 63A	R9XFH112	1225
Fork Busbar 1P 57MOD. 63A	R9XFH157	2727
Fork Busbar 2P 12MOD. 63A	R9XFH212	1412
Fork Busbar 2P 57MOD. 63A	R9XFH257	5230
Fork Busbar 3P 12MOD. 63A	R9XFH312	3187
Fork Busbar 3P 57MOD. 63A	R9XFH357	11407
Fork Busbar 4P 12MOD. 63A	R9XFH412	2939
Fork Busbar 4P 57MOD. 63A	R9XFH457	12276
Busbar Accessories		
Set of 10 End Caps 1P	R9XE110	*
Set of 10 End Caps 2P	R9XE210	*
Set of 10 End Caps 3P	R9XE310	*
Set of 10 End Caps 4P	R9XE410	*
Set of 20 Tooth Caps	R9XT20	*
Blanking Plate	13229B	62

Note: Blanking Plate MOQ = 10, All other MOQ = 1

Customized Distribution Boards to Suit Your Need - Available on Request*

- TV/Telephone DBs
- Pre-Wired DBs
- 8 Segment DBs
- Acrylic Door DBs
- IP54 DBs
- DBs with Phase Indication Lamps

*upto 32A socket only

*Please contact nearest Schneider Electric Sales Office or Customer Care Center for coordination chart

Please contact Customer Care Center for Stockable and Non stockable status of references.

NORMAL STOCK ITEMS

W.E.F. January 15th, 2026

Timers & Time Switches

Analog Time Switches



- 24H, 7D Programmable switch Voltage Rating: 230V AC +10%, -15%
- Memory: Upto 56 Switching Operations
- Back up of program: Operating reserve for 100, 200 Hours
- Overall dimensions: 5 modules
- Minimum time between two switching operations: 15, 30 min
- Accuracy: $\leq \pm 1$ s/day at +20°C

Description	Module Width 18mm/module	Reference	Unit MRP [₹]
IH 24H 16 A 15 mts interval 1 channel	1	15336	6338
IH 24H 16 A 30 mts interval 1 channel	1	CCT15365	6913
IH 7 day 16 A 1 channel- Max 21 On and 21 Off cycles	3	CCT15367	9896
IH 24H 16 A 30 mts 1 channel without reserve	3	CCT16364	5615

Digital Time Switches



- 7D, 24H Programmable switch .Voltage Rating: 230V AC +10%, -15%
- Consumption: 1 channel - max. 4VA; 2 channels - max. 7VA
- Memory: Upto 56 Switching Operations
- Back up of program & time by lithium battery: Operating reserve: 6 Years
- Overall dimensions: 5 modules
- Cable length: 100m
- Minimum time between two switching operations: 1 min

Description	Module Width 18mm/module	Reference	Unit MRP [₹]
IHP 1C w (24h/7d) programmable time switch	2.5	CCT15441	13622
IHP+ 1C (24h/7d) SMARTw programmable time switch	2.5	CCT15551	16805
IHP 2C w (24h/7d) programmable time switch	2.5	CCT15443	17572
IHP DCF (24h/7d) SMART programmable time switch	2.5	CCT15858	27662
IHP+ 2C (24h/7d) SMARTw programmable time switch	2.5	CCT15553	19441

Timers



- Switching capacity 16 A, max
- Delay range from 30 sec to 20 min
- Capacity for lighted pushbutton 150 mA
- Electric distribution busbar compatibility
- Output power capacity CCT15232-2300W
- Output power capacity CCT15223-3600W

Description	Module Width 18mm/module	Reference	Unit MRP [₹]
MINs - electronic timer - 0.5 to 20 min	1	CCT15232	7695
MINs - electronic timer - 0.5 to 20 min with switch Off Warning	1	CCT15233	9881
MINs - electronic timer - 0.5 to 20 min with switch Off Warning and Impulse relay function	1	CCT15234	9288

Please contact Customer Care Center for Stockable and Non stockable status of references.

W.E.F. January 15th, 2026

Timers & Time Switches

Twilight switch



- Includes wall mounted cell
- Adjustable brightness threshold 2 to 2000 Lux
- 2 LEDs to signal the sensor status and the output status
- Test button: To check the product and load cabling
- Switching capacity: 16Amp
- Screwless Terminals compatible with rigid and flexible wires
- Consumption 6 VA
- Size 45mm

Description	Module Width 18mm/module	Reference	Unit MRP [₹]
IC2000 outdoor (2 - 2000 lux) twilight switch	1	CCT15369	16229
Analogue indoor light sensor cell	-	CCT15262	8008
Wall mounted Analogue outdoor light sensor cell	-	CCT15263	12413
IC100 (2 - 100 lux) twilight switch	1	CCT15482	13652
IC2000 indoor (2 - 2000 lux) twilight switch	1	CCT15285	12167
IC2000p+ (2 - 2000 lux) programmable twilight switch	2.5	CCT15483	28199
IC100kp+ 1C (1 - 99000 lux) SMART programmable twilight switch	2.5	CCT15494	34106
IC100kp+ 2C (1 - 99000 lux) SMART programmable twilight switch	2.5	CCT15495	41987
IC Astro 2C SMART programmable twilight switch	2.5	CCT15245	29476
IC Astro 1C SMART programmable twilight switch	2.5	CCT15225	24803

Time switch accessories

Description	Module Width 18mm/module	Reference	Unit MRP [₹]
Programming kit for IHP / IC	1	CCT15860	12974

Thermostat

Description	Module Width 18mm/module	Reference	Unit MRP [₹]
THP1+ 1C (24h/7d) programmable thermostat	2.5	CCT15834	29513

Please contact Customer Care Center for Stockable and Non stockable status of references.

W.E.F. January 15th, 2026

Kaedra enclosures for PratiKa industrial sockets are part of a complete system of Watertight enclosures from 16A to 125A providing solutions for protection, control and electrical distribution for tertiary and industrial applications



- Degree of protection - IP65
- Impact strength - IK09
- Resistant to chemical and atmospheric agents, UVs etc.
- Self extinguishing class 2 insulating material
- Flame and abnormal heat resistance: 650°C
- Reversible front face for opening of door to left/right
- Combining of enclosures horizontally/vertically while still maintaining IP
- DIN channel can be positioned in 2 depths & 2 heights for cabling purpose

Mini Enclosures for modular devices



Description	Reference	Unit MRP [₹]
4 module	13441 <input checked="" type="checkbox"/>	4658
6 module	13442	5301
8 module	13443	6242
12 module	13444	10030

Enclosures for modular devices (with terminal blocks)



Description	Reference	Unit MRP [₹]
1 row 12 module	13431	11069
1 row 18 module	13432	14589
2 row 24 module	13433	16567
2 row 36 module	13434	20973
3 row 36 module	13435	21869
4 row 72 module	13437	41739

Mini Enclosure (suitable to mount modular devices and PratiKa 16A socket)



Description	Reference	Unit MRP [₹]
4 module 1 vertical opening	13175 <input checked="" type="checkbox"/>	2222
4 module 2 horizontal opening	13176	2741
4 module 3 horizontal opening	13177	3450

Note: For all above Reference MOQ = 1

Please contact Customer Care Center for Stockable and Non stockable status of references.

NORMAL STOCK ITEMS

W.E.F. January 15th, 2026

Enclosure (suitable to mount modular devices and PratiKa 16A / 32A sockets)



Description	Reference	Unit MRP [₹]
5 module 2 opening	13178 <input checked="" type="checkbox"/>	5348
8 module 4 horizontal opening	13179	7300
13 module 3 opening	13180	9646
13 module 6 opening	13181	10604
19 module 8 opening	13182	13665

Functional Plaques



Description	Reference	Unit MRP [₹]
Blank - marked for 1 socket 50x50	13135	692
Blank - marked for 1 socket 65x65 or 75x75	13137	692
Intermediate with 65x85 opening	13136	843
Intermediate with one opening for 65x85 & 90x100	13142	1399

Note: For all above Reference MOQ = 1

Please contact Customer Care Center for Stockable and Non stockable status of references.

NORMAL STOCK ITEMS

W.E.F. January 15th, 2026

Wander Plugs



PKE16M423



PKE16M723



81383

- Conforms to IEC 60309-1 & IEC 60309-2
- PK PratiKa Screw Connect: same orientation of clamp's screws
- External impact strength: IK08
- Glow wire test: 850°C

[In] Rated Current (A)	[Ue] Rated Operational Voltage (V)	Poles Description	Reference	Unit MRP [₹]
PratiKa Screw				
IP44				
16	200...250	2P + E	PKE16M423 <input checked="" type="checkbox"/>	678
		2P + E	PKX16M423 <input type="checkbox"/>	1383
	380...415	3P + E	PKE16M434 <input checked="" type="checkbox"/>	866
		3P + N + E	PKE16M435 <input checked="" type="checkbox"/>	903
32	200...250	2P + E	PKE32M423 <input checked="" type="checkbox"/>	1066
		3P + E	PKE32M434 <input checked="" type="checkbox"/>	1250
	380...415	3P + N + E	PKE32M435 <input checked="" type="checkbox"/>	1221
		IP67		
16	200...250	2P + E	PKE16M723 <input checked="" type="checkbox"/>	1481
		2P + E	PKX16M723 <input type="checkbox"/>	2201
	380...415	3P + E	PKE16M734 <input checked="" type="checkbox"/>	1689
		3P + N + E	PKE16M735 <input checked="" type="checkbox"/>	1805
32	200...250	2P + E	PKE32M723 <input checked="" type="checkbox"/>	2116
		3P + E	PKE32M734 <input checked="" type="checkbox"/>	2282
	380...415	3P + N + E	PKE32M735 <input checked="" type="checkbox"/>	2278
		PK (63A & 125A available in IP67 only)		
63	200...250	2P + E	81378	5998
		3P + E	81382 <input checked="" type="checkbox"/>	5717
	380...415	3P + N + E	81383 <input checked="" type="checkbox"/>	5672
125	380...415	3P + E	81394	17491
		3P + N + E	81395	17491

Note: * Fast Connection

Small Wall Mounted Sockets



PKF16W423



PKF16W723



PKF32W735

- Conforms to IEC 60309-1 & IEC 60309-2
- External impact strength: IK08
- Glow wire test: 850°C

[In] Rated Current (A)	[Ue] Rated Operational Voltage (V)	Poles Description	Reference	Unit MRP [₹]
IP44				
16	200...250	2P + E	PKF16W423	1198
		3P + E	PKF16W434	1390
	380...415	3P + N + E	PKF16W435	1518
		32	200...250	2P + E
3P + E	PKF32W434			1879
380...415	3P + N + E		PKF32W435	1985
	IP67			
16	200...250	2P + E	PKF16W723	1903
		3P + E	PKF16W734	2391
	380...415	3P + N + E	PKF16W735	2472
		32	200...250	2P + E
3P + E	PKF32W734			3478
380...415	3P + N + E		PKF32W735	4613

Note: For all above Reference MOQ = 1

Please contact Customer Care Center for Stockable and Non stockable status of references.

*Bold references are MTO reference.

Wall Mounted Sockets



- Conforms to IEC 60309-1 & IEC 60309-2
- Rated operational voltage upto 415V
- Rated operational current upto 125A
- External impact strength: IK08
- Glow wire test: 850°C
- Available only in IP67

[In] Rated Current (A)	[Ue] Rated Operational Voltage (V)	Poles Description	Reference	Unit MRP [₹]
63	200...250	2P + E	81178	7388
		3P + E	81182 ●	8139
	380...415	3P + N + E	81183	7714
125	380...415	3P + E	81194	26647
		3P + N + E	81195	26777

Wander Sockets



- PK PratiKa Screw Connect: same orientation of clamp's screws.
- PK PratiKa: 16A & 32A; IP44 & IP67
- External impact strength: IK08
- Glow wire test: 850 °C
- Conforms to IEC 60309-1 & IEC 60309-2

[In] Rated Current (A)	[Ue] Rated Operational Voltage (V)	Poles Description	Reference	Unit MRP [₹]
PratiKa Screw				
IP44				
16	200...250	2P + E	PKF16M423 ✓	948
		2P + E	PKY16M423	1044
	380...415	3P + E	PKF16M434	1093
		3P + N + E	PKF16M435	1193
32	200...250	2P + E	PKF32M423 ✓	1303
		3P + E	PKF32M434	1582
	380...415	3P + N + E	PKF32M435 ✓	1592
		IP67		
16	200...250	2P + E	PKF16M723	1755
		2P + E	PKY16M723 ●	2135
	380...415	3P + E	PKF16M734	2201
		3P + N + E	PKF16M735	2299
32	380...415	2P + E	PKF32M723	2413
		3P + E	PKF32M734	2670
	3P + N + E	PKF32M735	2695	
PK (63A & 125A available in IP67 only)				
63	200...250	2P + E	81478	6533
	380...415	3P + E	81482	6590
		3P + N + E	81483	6633
125	380...415	3P + E	81494	20622
		3P + N + E	81495	21026

Also Available on Request:

- Patented FAST connect Plugs & Sockets - innovative cabling system that enables connection without stripping the conductor and with absolutely no screws required
 - Extra Low Voltage Plugs & Sockets down to 50V
- Please contact nearest Schneider Electric Sales Office or Customer Care for Reference and Prices

Note: For all above Reference MOQ = 1

Please contact Customer Care Center for Stockable and Non stockable status of references.
*Bold references are MTO reference.

Panel Mounted Sockets - Angled



- PK PratiKa Screw Connect: same orientation of clamp's screws
- External impact strength: IK08
- Glow wire test: 850°C
- Conforms to IEC 60309-1 & IEC309-2

[In] Rated Current (A)	[Ue] Rated Operational Voltage (V)	Poles Description	Reference	Unit MRP [₹]
PratiKa Screw				
IP44				
16	200...250	2P + E	PKF16F423 <input checked="" type="checkbox"/>	777
		2P + E	PKY16F423 ●	791
	380...415	3P + E	PKF16F434	1093
		3P + N + E	PKF16F435 <input checked="" type="checkbox"/>	1166
32	200...250	2P + E	PKF32F423 <input checked="" type="checkbox"/>	1290
	380...415	3P + E	PKF32F434	1512
		3P + N + E	PKF32F435	1491
IP67				
16	200...250	2P + E	PKF16F723 <input checked="" type="checkbox"/>	1368
	380...415	2P + E	PKY16F723 ●	1673
		3P + E	PKF16F734	1573
32	200...250	3P + N + E	PKF16F735 <input checked="" type="checkbox"/>	1592
	380...415	2P + E	PKF32F723	1798
		3P + E	PKF32F734	2101
		3P + N + E	PKF32F735	2115
PK (63A & 125A available in IP67 only)				
63	200...250	2P + E	81278	5898
	380...415	3P + E	81282 <input checked="" type="checkbox"/>	5908
		3P + N + E	81283 <input checked="" type="checkbox"/>	5967
125	380...415	3P + E	81294	19899
		3P + N + E	81295	19805

Panel Mounted Sockets - Straight



- PK PratiKa Screw Connect: same orientation of clamp's screws
- External impact strength: IK08
- Glow wire test: 850°C
- Conforms to IEC 60309-1 & IEC309-2

[In] Rated Current (A)	[Ue] Rated Operational Voltage (V)	Poles Description	Reference	Unit MRP [₹]
PratiKa Screw				
IP44				
16	200...250	2P + E	PKF16G423	831
		2P + E	PKY16G423	1231
	380...415	3P + E	PKF16G434	1448
		3P + N + E	PKF16G435	1250
32	200...250	2P + E	PKF32G423	1318
	380...415	3P + E	PKF32G434	1518
		3P + N + E	PKF32G435	1645
IP67				
16	200...250	2P + E	PKF16G723	1390
	380...415	2P + E	PKY16G723 ●	1566
		3P + E	PKF16G734	1912
32	380...415	3P + N + E	PKF16G735	1592
		2P + E	PKF32G723	1773
	200...250	3P + E	PKF32G734	1994
		3P + N + E	PKF32G735	2069
PK (63A & 125A available in IP67 only)				
63	380...415	3P + E	81682	5966
		3P + N + E	81683	5966
		3P + N + E	81695	19995

*Fast Connection

Note: For all above Reference MOQ = 1

Please contact Customer Care Center for Stockable and Non stockable status of references.

*Bold references are MTO reference.

Sockets with Interlock Switches - for guaranteed safety of operation

- Allows closure of main switch only when the plug is fully inserted in socket - when complete mechanical & electrical connection has occurred
- Plug removal is possible only when the switch is in "off" position

Wall Mounted Sockets with Interlock Switch Unika (w/o protection)



83047

83081

- Switch designed for use in AC 22A class applications
- Conforms to IEC 60309-1 & IEC 60309-2
- Rated operational voltage upto 415V
- Rated operational current upto 32A
- External impact strength: IK08
- Available in IP44 / IP65 versions
- Glow wire test: 750°C

[In] Rated Current (A)	[Ue] Rated Operational Voltage (V)	Poles Description	Reference	Unit MRP [₹]
IP44				
16	200...250	2P + E	83031	9970
	380...415	3P + N + E	83036	14072
32	200...250	2P + E	83042 <input checked="" type="checkbox"/>	12820
	380...415	3P + E	83046	20950
		3P + N + E	83047	15107
IP65				
16	200...250	2P + E	83081	10315
	380...415	3P + E	83085	14206
		3P + N + E	83086	14494
32	200...250	2P + E	83092	13519
	380...415	3P + N + E	83097	16232

Socket with Interlock Switch & DIN Rail Isoblock (4.5 modules)



82754

83796

- Switch designed for use in AC- 22A class applications
- Conforms to IEC 60309-1 & IEC 60309-2
- Provision to DIN mount 4.5 module device
- External impact strength: IK10
- Available in IP65 version
- Glow wire test: 850°C

[In] Rated Current (A)	[Ue] Rated Operational Voltage (V)	Poles Description	Reference	Unit MRP [₹]
16	200...250	2P + E	82754 <input checked="" type="checkbox"/>	12242
	380...415	3P + N + E	82759	18900
32	200...250	2P + E	83791 <input checked="" type="checkbox"/>	14494
	380...415	3P + E	83795	21043
		3P + N + E	83796	17267

Socket with Interlock Switch & DIN Rail Isoblock (6 modules)



82766

- Switch designed for use in AC- 22A class applications
- Conforms to IEC 60309-1 & IEC 60309-2
- Provision to DIN mount 6 module device
- External impact strength: IK10
- Available in IP65 version
- Glow wire test: 850°C

[In] Rated Current (A)	[Ue] Rated Operational Voltage (V)	Poles Description	Reference	Unit MRP [₹]
32	200...250	2P + E	82766	19304
63	380...415	3P + E	82782	26011
		3P + N + E	82783	25845

Please contact Customer Care Center for Stockable and Non stockable status of references.

*Bold references are MTO reference.

ELECTRA Metal Clad Plugs & Sockets are specially designed incorporating the latest safety, quality and user friendly features.

Construction

- The casting is made from non-corroding die-cast aluminum alloy combining exceptional compactness with high strength
- The design/construction eliminates the possibility of mismatch in fitting of plugs in corresponding sockets
- The floating contacts in the sockets are self aligning and facilitates smooth plugging in without undue pressure (These can be easily removed for wiring)
- A provision for pilot pin facilitates mechanical interlocking in case of 63A ratings

Human Safety

Specially designed shroud to avoid accidental finger contact with plug-pins while inserting/removing the plug
Similarly, the contact tubes in sockets are deeply recessed to avoid human contact

- The earthing pins ensure that earth connection is made first and broken last, being longer than conducting pins
- The visible earth terminals facilitate easy checking of earth connection
- The cable grip to the plug is made very strong by providing a compression gland and by protecting it at the point of entry by a strong rubber guard

Applications

Industrial, Commercial & Domestic portable equipments like Hand/Power Tools, Industrial Ovens, Welding Sets, Mobile Generators, Furnaces, Ships, Office Machines, Refrigerators, Coolers, Air-Conditioners, Overhead Cranes, Chilling Cabinets, Tile Polishers and Sewing Machines

Plug



Rating (A)	Poles Description	Voltage (V)	MOQ	Reference	Unit MRP [₹]
10	2P	250	30	AP10 <input checked="" type="checkbox"/>	316
20	2P	250	30	AP20 <input checked="" type="checkbox"/>	333
20	3P	440	30	BP20 <input checked="" type="checkbox"/>	443
30	3P	440	20	BP30 <input checked="" type="checkbox"/>	806
63	3P+N+E	440	4	CP63 <input checked="" type="checkbox"/>	3644

Socket



Rating (A)	Poles Description	Voltage (V)	MOQ	Reference	Unit MRP [₹]
10	2P	250	30	AS10 <input checked="" type="checkbox"/>	333
20	2P	250	30	AS20 <input checked="" type="checkbox"/>	355
20	3P	440	30	BS20 <input checked="" type="checkbox"/>	497
30	3P	440	20	BS30 <input checked="" type="checkbox"/>	853
63	3P+N+E	440	4	CS63 <input checked="" type="checkbox"/>	4082

Please contact Customer Care Center for Stockable and Non stockable status of references.
*Bold references are MTO reference.

Complete range of switches & sockets suitable for both indoor & outdoor applications like Kitchens, Swimming Pools, Landscape Gardens, Exterior Walls and Other Environmentally Challenged Locations.



56SW116LE-GY



56SW216LE-GY



56SW332LE-GY

Description	IP Rating	Reference	Unit MRP [₹]
Surface Switches			
Single Pole Switches Less Enclosure			
1 Pole 250V 10A	IP66	56SW110LE-GY	4396
1 Pole 250V 16A	IP66	56SW116LE-GY	4079
1 Pole 250V 20A	IP66	56SW120LE-GY	6176
1 Pole 250V 32A	IP66	56SW132LE-GY	7365
Double Pole Switches Less Enclosure			
2 Pole 500V 16A	IP66	56SW216LE-GY	7115
2 Pole 500V 20A	IP66	56SW220LE-GY	7115
2 Pole 500V 32A	IP66	56SW232LE-GY	9442
2 Pole 500V 50A	IP66	56SW250LE-GY	11027
Triple Pole Switches Less Enclosure			
3 Pole 500V 10A	IP66	56SW310LE-GY	6581
3 Pole 500V 16A	IP66	56SW316LE-GY	6865
3 Pole 500V 20A	IP66	56SW320LE-GY	7227
3 Pole 500V 32A	IP66	56SW332LE-GY	8347
3 Pole 500V 50A	IP66	56SW350LE-GY	9722
3 Pole 500V 63A	IP66	56SW363LE-GY	11285
Four Pole Switches Less Enclosure			
4 Pole 500V 20A	IP66	56SW420LE-GY	9542



66CV563-RG



66P563-EO

Description	IP Rating	Reference	Unit MRP [₹]
IP66 Industrial Combination Switch Sockets with Enclosure			
Single Pole Switches Less Enclosure			
500V, 63A with 4 pole switch and 63A 5 Pin Socket	IP66	66CV563-RG	127903
Plug Top 5 Pin 500V 63A	IP66	66P563-EO	38390

Please contact Customer Care Center for Stockable and Non stockable status of references.

*Bold references are MTO reference.



56SO316RP-LE-GY-EX



56SO432LE-GY



56SO532LE-GY

Description	IP Rating	Reference	Unit MRP [₹]
Surface Socket Outlets			
3 Pin Sockets Less Enclosure			
3 Pin 250V 16A Indian Standard	IP66	56SO316RP-LE-GY-EX	4106
3 Pin 250V 20A Round Pin	IP66	56SO320LE-GY	5960
3 Pin 250V 32A Round Pin	IP66	56SO332LE-GY	6639
4 Pin Sockets Less Enclosure			
4 Pin 500V 20A Round Pin	IP66	56SO420LE-GY	8903
4 Pin 500V 32A Round Pin	IP66	56SO432LE-GY	10645
4 Pin 500V 50A Round Pin	IP66	56SO450LE-GY	16379
5 Pin Sockets Less Enclosure			
5 Pin 500V 10A Round Pin	IP66	56SO510LE-GY	9620
5 Pin 500V 20A Round Pin	IP66	56SO520LE-GY	9529
5 Pin 500V 32A Round Pin	IP66	56SO532LE-GY	11316
5 Pin 500V 40A Round Pin	IP66	56SO540LE-GY	16484
5 Pin 500V 50A Round Pin	IP66	56SO550LE-GY	16923

*Alternate reference 56SO440-GY (coming soon)



56PA420-EO



56PA532-EO



56CVI520-GY

Description	IP Rating	Reference	Unit MRP [₹]
Plugs			
3 Pin Angle Plugs			
3 pin 250V 16A Round Pin	IP66	56PA316RP-GY-EX	3088
3 Pin 250V 20A Round Pin	IP66	56PA320-EO	6176
3 Pin 250V 32A Round Pin	IP66	56PA332-EO	7135
4 Pin Angle Plugs			
4 Pin 500V 20A Round Pin	IP66	56PA420-EO	7599
4 Pin 500V 32A Round Pin	IP66	56PA432-EO	7910
4 Pin 500V 40A Round Pin	IP66	56PA440-EO	13156
4 Pin 500V 50A Round Pin	IP66	56PA450-EO	9386
5 Pin Angle Plugs			
5 Pin 500V 10A Round Pin	IP66	56PA510-EO	7469
5 Pin 500V 20A Round Pin	IP66	56PA520-EO	7469
5 Pin 500V 32A Round Pin	IP66	56PA532-EO	8547
5 Pin 500V 40A Round Pin	IP66	56PA540-EO	9126
5 Pin 500V 50A Round Pin	IP66	56PA550-EO	9343
Combination Switch Socket Outlet			
IP66 Interlocked Switch Socket with Enclosure			
4 Pin 500V 20A Round Pin	IP66	56CVI420-GY	32648
5 Pin 500V 20A Round Pin	IP66	56CVI520-GY	29536
5 Pin 500V 32A Round Pin	IP66	56CVI532-GY	29806

Please contact Customer Care Center for Stockable and Non stockable status of references.

*Bold references are MTO reference.

56 Series



56DB2-GY



56CB4N-GY

Description	IP Rating	Reference	Unit MRP [₹]
Adaptable Enclosures with Gear Tray			
2 Gangpoints, 198X101X140mm	IP66	56DB2-GY	8149
Junction Boxes			
3 Gangpoints, 300X101X90mm	IP66	56JB3-GY	12214
4 Gangpoints, 204X198X90mm	IP66	56JB4-GY	11466

Description	Module Width	Reference	Unit MRP [₹]
Switchgear Cover Assembly			
For 1,2,3 Pole MCB with 4 Pole RCD (max. 4M Width)	4	56CB4N-GY	6769



56FA2-GY



56E2-GY



56E1-GY

Description	No. of Gangs	Reference	Unit MRP [₹]
Flush Surrounds			
Flush Surround	2	56FA2-GY	3335
Flush Surround	3	56FA3-GY	5251
Mounting Enclosures (Back Boxes)			
101X101X63mm	1	56E1-GY	1437
198X101X63mm	2	56E2-GY	3686

Please contact Customer Care Center for Stockable and Non stockable status of references.
 *Bold references are MTO reference.

SWITCH TO STYLE



Perfect solutions for the perfect you



LIVIA
Life. Style.



Miluz Lara

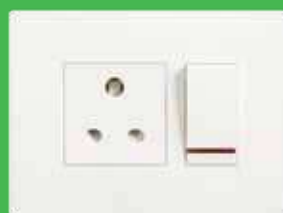

Opale



Unica Pure



ZENcelo



Avatar On

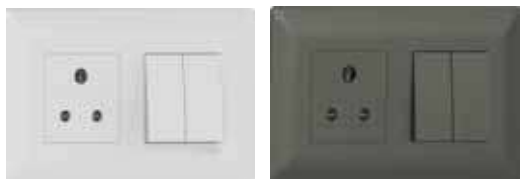

- **Sleek Design** - 2.7mm thin plate with curved body to minimize dust accumulation
- **Stylish Looks** - Soft white texture with glossy finish
- **Robust & Strong** - Innovative honeycomb designed grid plate for extra rigidity
- **Reliable** - High grade heat-resistant polycarbonate and laser marked wiring diagrams.
- **Easy to Install** - Snap-In / Snap-Out front loading modules and Bigger terminal holes
- **Green & Eco Friendly** - RoHS compliant range



Description	Reference for White	Unit MRP [₹]	Reference for Pristine Grey	Unit MRP [₹]
Switches				
10AX 1 way switch	P1001_N	145	P1001_PG_N	211
10AX 1 way switch with Indicator lamp	P1081	314	P1081_PG_N	415
10AX 2 way switch	P1002_N	246	P1002_PG_N	310
16AX 1 way switch	P1101_N	268	P1101_PG_N	329
16AX 1 way switch with Indicator lamp	P1181_N	373	P1181_PG_N	443
16AX 1 way switch (2M)	P1121_N	407	P1121_PG_N	529
16AX 2 way switch	P1102_N	365	P1102_PG_N	478
20A 1 way switch (1M) with indicator lamp	P11201_N	343	P11201_PG_N	393
20A DP switch with Indicator lamp	P1120_N	614	P1120_PG_N	800
32A DP switch with Indicator lamp	P1132_N	900	P1132_PG_N	1110
Bell Push				
10A Bell Push switch	P1005_N	275	P1005_PG_N	349
10A Bell Push switch (2M)	P1025_N	394	P1025_PG_N	468
10A bell push switch with Indicator	P1085_N	335	P1085_PG_N	444
10A bell push switch with Indicator (2M)	P1086_N	440	P1086_PG_N	558
Sockets				
6A 3Pin socket Outlet with shutter (BIS)	P2005NS_N	289	P2005NS_PG_N	356
10A/16A 3-pin Socket Outlet with Shutter	P2106_N	435	P2106_PG_N	527
Fan Regulators & Dimmers				
Step type fan regulator (1M)	P3100_N	872	P3100_PG_N	1060
Step type fan regulator (2M)	P3200_N	1007	P3200_PG_N	1258
Dimmer 400W (1M)	P3004_N	1629	P3004_PG_N	2106
Dimmer 1000W (2M)	P3012	2424	P3012_PG_N	2658
USB Charger				
USB Charger	P7002_N	2132	P7002_PG_N	2478
Livia - A+C Type USB Charger (1M)	P7003_N	3210	P7003_PG_N	3864
Accessories				
RJ 11 Telephone outlet with shutter	P4011_N	250	P4011_PG_N	329
RJ 45 Cat 5e Data outlet with shutter	P4045_N	849	P4045_PG_N	1018
RJ 45 Cat6 Data outlet with shutter	P4046_N	945	P4046_PG_N	1204
TV socket	P4500_N	238	P4500_PG_N	318
Blank off unit (1M)	P0001_N	65	P0001_PG_N	84
Foot Lamp with LED	P7001_N	1026	P7001_PG_N	1222
Cord Outlet	-	-	P4550_PG_N	343
LED Phase Indicator	P5001_N	416	-	-
Mini MCB				
10A Mini MCB	P8010_N	591	P8010_PG_N	693
16A Mini MCB	P8016_N	591	P8016_PG_N	693
20A Mini MCB	P8020_N	591	P8020_PG_N	693
25A Mini MCB	P8025_N	591	P8025_PG_N	693
32A Mini MCB	P8032_N	591	P8032_PG_N	693

* Available till stocks lasts

Please contact Customer Care Center for Stockable and Non stockable status of references.

*Bold references are MTO reference.



P1186MS_N



P6002_N



P6004_N



P0703_N



P0704_N



P0706_PG_N

Description	Reference for White	Unit MRP [₹]	Reference for Pristine Grey	Unit MRP [₹]
Motor Starter Switch				
25A Motor Starter switch	P1186MS_N	1533	P1186MS_PG_N	1925
Hotel Series				
DND Switch	P6002_N	350	P6002_PG_N	379
MMR Switch	P6004_N	321	P6004_PG_N	379
DND & MMR Indicator	P6013	1024	P6013_PG_N	1223
20A Key Card Switch - Electronic (3M)	P6005_N	5436	P6005_PG_N	7117

Description	Reference for White	Unit MRP [₹]	Reference for Pristine Grey	Unit MRP [₹]
Cover Plates				
1-2 M Grid & 1 M Cover Frame	P0701_N	168	P0701_PG_N	202
1-2 M Grid & 2 M Cover Frame	P0702_N	168	P0702_PG_N	205
3 M Grid & 3 M Cover Frame	P0703_N	212	P0703_PG_N	241
4 M Grid & 4 M Cover Frame	P0704_N	245	P0704_PG_N	299
6 M Grid & 6 M Cover Frame	P0706_N	314	P0706_PG_N	392
8 M Grid & 8 M Cover Frame - Horizontal	P0708_N	412	P0708_PG_N	492
8 M Grid & 8 M Cover Frame - Square	P0709_N	497	P0709_PG_N	597
9 M Grid & 9M Cover Frame	P07010_N	465	P07010_PG_N	725
12 M Grid & 12 M Cover Frame	P0712_N	593	P0712_PG_N	725
16 M Grid & 16M Cover Frame	P07016_N	713	P07016_PG_N	988
18 M Grid & 18 M Cover Frame	P0718_N	883	P0718_PG_N	1043

Please contact Customer Care Center for Stockable and Non stockable status of references.
*Bold references are MTO reference.



A fusion of beauty and functionality:

- Dew-drop-inspired design prevents dust and dirt accumulation.
- The 'volcanic' curve ensures ample room for wiring, for a seamless user experience.

Ideal for Mivan and modern construction methods:

- Seamlessly fits into newer (40 mm.) and conventional (50 mm.) metal boxes.

Durability and Safety:

- Prevents accidental shocks with no single-pin insertion in sockets.
- Durable copper contact for an enhanced life span (lasts up to 2 lakh clicks, or 30 years, at 15 clicks/day)

Effortless Installation:

- Clear markings for ideal wire strip length for accurate and safe installation
- Front-loading components and double-sided wire entry in sockets for greater ease.

Seamless Connectivity:

- Wiser™ is designed to optimize energy usage and is fully compatible with Miluz Lara switches and sockets.

Now Miluz Lara comes with the 10 years of warranty

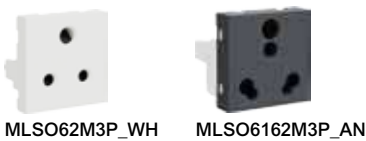
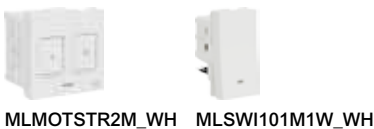

Description	Reference for White	Unit MRP [₹]	Pack	Reference for Anthracite	Unit MRP [₹]	Pack
Switches						
10 A 1-way Switch (1M)	MLSW101M1W_WH	126	20	MLSW101M1W_AN	145	20
10 A 1-way Switch with Indicator (1M)	MLSWI101M1W_WH	296	20	MLSWI101M1W_AN	321	20
10 A 1-way Switch (2M)	MLSW102M1W_WH	321	10	MLSW102M1W_AN	348	10
10 A 1-way Switch with Indicator (2M)	MLSWI102M1W_WH	354	10	MLSWI102M1W_AN	402	10
10 A 2-way Switch (1M)	MLSW101M2W_WH	253	20	MLSW101M2W_AN	291	20
16 A 1-way Switch (1M)	MLSW161M1W_WH	271	20	MLSW161M1W_AN	312	20
16 A 1-way Switch with Indicator (1M)	MLSWI161M1W_WH	382	20	MLSWI161M1W_AN	439	20
16 A 1-way Switch (2M)	MLSW162M1W_WH	465	10	MLSW162M1W_AN	535	10
16 A 1-way Switch with Indicator (2M)	MLSWI162M1W_WH	502	10	MLSWI162M1W_AN	578	10
16 A 2-way Switch (1M)	MLSW161M2W_WH	409	20	MLSW161M2W_AN	482	20
20 A DP Switch with Indicator (2M)	MLSWI202MDP_WH	646	10	MLSWI202MDP_AN	840	10
32 A DP Switch with Indicator (2M)	MLSWI322MDP_WH	1063	10	MLSWI322MDP_AN	1165	10
Motor Starter Switch						
25 A Motor Starter Switch (2M)	MLMOTSTR2M_WH	1606	10	MLMOTSTR2M_AN	1847	10
Bell Push Switch						
6 A Bell Push (1M)	MLBP1M_WH	286	20	MLBP1M_AN	362	20
6 A Bell Push with Indicator (1M)	MLBPI1M_WH	347	20	MLBPI1M_AN	452	20
6 A Bell Push (2M)	MLBP2M_WH	397	10	MLBP2M_AN	527	10
6 A Bell Push with Indicator (2M)	MLBPI2M_WH	462	10	MLBPI2M_AN	573	10
Sockets						
6 A 3 Pin Socket with Shutter (2M)	MLSO62M3P_WH	251	10	MLSO62M3P_AN	289	10
6 A/16 A 3P Socket with Shutter (2M)	MLSO6162M3P_WH	402	10	MLSO6162M3P_AN	462	10
6A Switched Socket 2M	MLSWSO62M_WH	439	10	MLSWSO62M_AN	526	10
Fan Regulators and Dimmers						
4-Step Fan Regulator (1M)	MLFR4STP1M_WH	874	20	MLFR4STP1M_AN	1006	20
5-Step Fan Regulator (2M)	MLFR5STP2M_WH	1104	10	MLFR5STP2M_AN	1270	10
400 W Dimmer (1M)	MLDMR1M_WH*	1537	10	MLDMR1M_AN*	1768	10
USB Charger						
2.1 A USB Charger (1M)	MLUSBA1M_WH	2019	10	MLUSBA1M_AN	2210	10
1M 12 W Type A+C USB Charger (1M)	MLUSBAC1M_WH	3014	20	MLUSBAC1M_AN	3466	20
USB A+C 21W PD Horizontal	MLUSBAC2MPDH_WH	4150	10	MLUSBAC2MPDH_AN	4979	10
Air Quality Indicator						
Air Quality Indicator (2M)	MLAQI2M_WH*	-	-	MLAQI2M_AN*	-	-
Voltage Surge Protector						
Voltage Surge Protector 230 V (1M)	MLVSP1M_WH	2430	10	MLVSP1M_AN	2794	10

*Prices will be shared on request

Please contact Customer Care Center for Stockable and Non stockable status of references.

*Bold references are MTO reference.



Description	Reference for White	Unit MRP [₹]	Pack	Reference for Anthracite	Unit MRP [₹]	Pack
Accessories						
TV Socket (1M)	MLTV1M_WH	239	10	MLTV1M_AN	311	10
RJ11 Tel. Outlet with Shutter (1M)	MLRJ111M_WH	249	10	MLRJ111M_AN	326	10
RJ45 Cat. 6 Data Outlet Shuttered (1M)	MLRJ451M_WH	904	10	MLRJ451M_AN	1105	10
Preterminated HDMI socket (1M)	MLHDMI1M_WH	1507	10	MLHDMI1M_AN	1733	10
LED Footlamp (2M)	MLFTLMP2M_WH	954	10	MLFTLMP2M_AN	1055	10
Door Chime (2M)	MLDRCHM2M_WH*	1205	-	MLDRCHM2M_AN*	1386	-
Blank Off Unit (1M)	MLBLANK1M_WH	62	20	MLBLANK1M_AN	80	20
Socket Adaptor (2M)	MLSA2M_NC	141	10	-	-	-
LED Phase Indicator (Red) (1M)	MLPHSIND1M_RD	402	10	-	-	-
MCB						
16A MCB SP 1M C curve	MLMM161P_WH	804	10	MLMM161P_AN	854	10
20A MCB SP 1M C curve	MLMM201P_WH	804	10	MLMM201P_AN	854	10
32A MCB SP 1M C curve	MLMM321P_WH	804	10	MLMM321P_AN	854	10
Hospitality						
Curtain Control Switch	MLCCSW2M_WH	870	10	MLCCSW2M_AN	999	10
DND MMR Switch	MLDMSW2M_WH	854	10	MLDMSW2M_AN	979	10
DND MMR Indicator, ANTHRACITE	MLDMI1M_NA	653	10	-	-	-
Electronic Keycard Switch	MLKECRDSW2M_WH	4520	10	MLKECRDSW2M_AN	5023	10
115V Shaver Socket Horizontal	MLSHVRSO3M_WH	4018	10	MLSHVRSO3M_AN	4520	10
Cover Plates						
1M or 2M Grid and 1M Cover Frame	MLCP1M_WH	172	15	MLCP1M_AN	223	15
1M or 2M Grid and 2M Cover Frame	MLCP2M_WH	172	15	MLCP2M_AN	223	15
3M Grid and 3M Cover Frame	MLCP3M_WH	220	10	MLCP3M_AN	287	10
3M Uni Grid and 3M Cover Frame	MLCP3MU_WH	241	10	MLCP3MU_AN	313	10
4M Grid and 4M Cover Frame	MLCP4M_WH	254	8	MLCP4M_AN	330	8
6M Grid and 6M Cover Frame	MLCP6M_WH	320	5	MLCP6M_AN	416	5
8M Grid and 8M Cover Frame, Horizontal	MLCP8MH_WH	422	5	MLCP8MH_AN	549	5
8M Grid and 8M Cover Frame, Square	MLCP8MS_WH	554	5	MLCP8MS_AN	721	5
9M Cover Frame + 8M Grid	MLCP9M_WH	521	5	MLCP9M_AN	677	5
12M Grid and 12M Cover Frame	MLCP12M_WH	671	5	MLCP12M_AN	873	5
16M Cover Frame and Grid	MLCP16M_WH	799	5	MLCP16M_AN	1039	5
18M Grid and 18M Cover Frame	MLCP18M_WH	966	5	MLCP18M_AN	1256	5

Please contact Customer Care Center for Stockable and Non stockable status of references.
*Bold references are MTO reference.

Wiring Diagram Miluz Lara

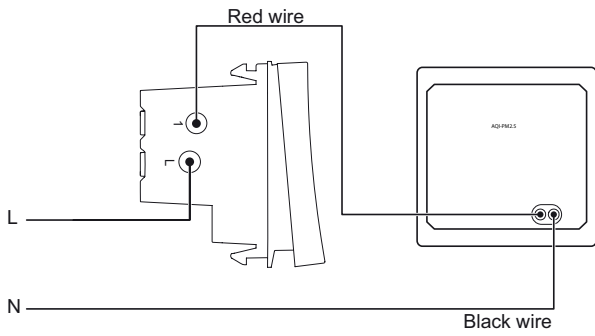

> Air Quality Indicator
MLAQI2M_WH, MLAQI2M_AN

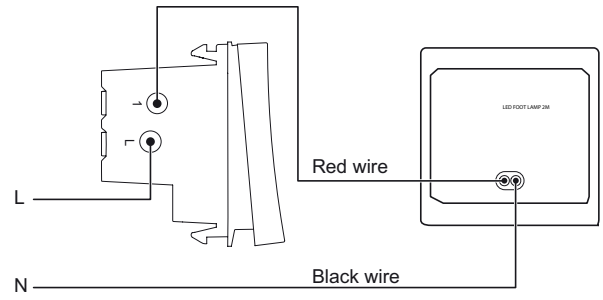

> LED Footlamp
MLFTLMP2M_WH, MLFTLMP2M_AN

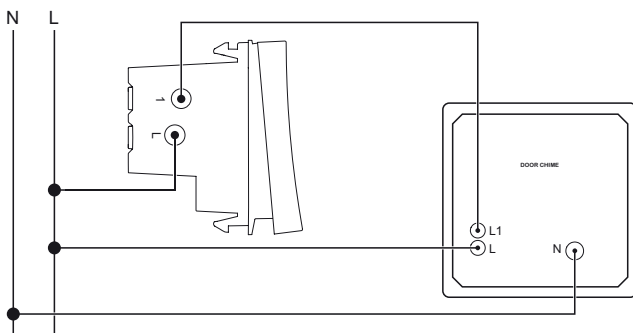

> Door Chime
MLDRCHM2M_WH, MLDRCHM2M_AN

12 W Type A+C USB Charger

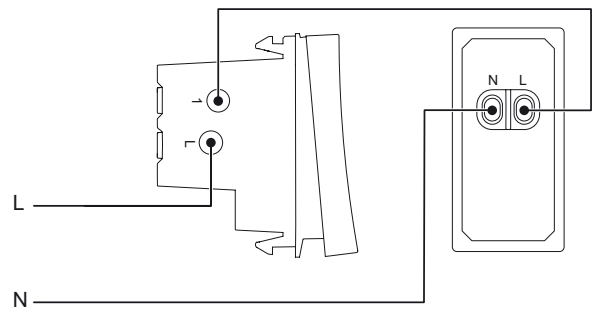

> USB Chargers
MLUSBAC1M_WH, MLUSBAC1M_AN

10 Years Warranty T&C

- Schneider Electric shall, at its sole discretion, repair or replace switches upto 16A (without LED indicator/lamp) and or 6A & 16A sockets in white color only if the Product is found to be having manufacturing defect (means defects solely as a result of faulty material and/or workmanship during manufacturing of Product) within 10 years from the date of manufacture of Product or from the date of invoice of Product, whichever is earlier.
- For all other wiring accessories, the warranty shall be 18 months starting from the date of delivery or 24 months from the date of manufacturing, whichever is earlier
- The warranty defines Schneider Electric's overall sole liability which does not include any other liability whatsoever including without limitation consequential losses or damages or re-installation costs arising from or in relation to the defective products.
- Schneider Electric reserves the right to change and/or improve the design of its Products without prior notice
- In any event whatsoever, if same Product with a similar design is not available, the Product will be replaced with an equivalent model available at that time at sole discretion of Schneider Electric.
- ***This warranty for the above products shall be rendered null & void in case of the following:***
 - a. If the original Schneider Electric mounting boxes have not been used to mount the plates & accessories.
 - b. If any attempt has been made to rectify, dismantle, tamper, or alter the product by any third party or by the customer himself.
 - c. If any damage resulting from the use of any cleaning chemicals on the Product which can adversely affect the product material (Like Acetone, Thinner, turpentine Oil etc.)
 - d. If the products are not installed as per the appropriate design specifications
- Warranty facilitations as per the standard process where customer to contact Customer Care Center (Email, Toll Free, chat) with relevant details & Log the complaint.

Opale - Switches with Satin Finish



- **Patented Smooth Satin Finish** - Scratch Resistant, Easy to Clean & Prevents light reflection off surface
- **Safe to Use** - High grade flame retardant polycarbonate material & Child Proof sockets with unique shutter design
- **Hassle Free Operation** - 'Soft sound' switches with Gold plated Data Socket contacts for better connection
- **Easy to Install** - Snap-In / Snap-Out front loading modules and terminals with indented screws
- **Green & Eco Friendly** - RoHS compliant range



X1001WH



X1286WH



X1186WH



X1005WH



X1085WH



X2005WHNS



X2106WH



X3200WHCM



X3104WH



X7003WH



X5001

Description	Reference for White	Unit MRP [₹]	Pack	Reference for Coke Grey	Unit MRP [₹]	Pack
Switches						
6AX 1 way switch	X1001WH	262	20	AAKY1001	332	20
6AX 1 way switch with Indicator lamp	X1081WH	491	20	-	-	-
6AX 2 way switch	X1002WH	367	20	-	-	-
16AX 1 way switch	X1101WH	420	20	AAKY1101	531	20
16AX 1 way switch with Indicator lamp	X1181WH	600	20	AAKY1181	702	20
16AX 2 way switch	X1102WH	566	20	-	-	-
20A DP switch with Indicator (2M)	X1286WH	992	10	-	-	-
32A DP switch (2M)	AAKX1232	1491	10	-	-	-
Motor Starter Switch						
25A Motor Starter switch	X1186WH	2809	10	-	-	-
Bell Push						
6A Bell Push	X1005WH	411	20	-	-	-
6A Bell Push (2M)	X1025WH	588	10	-	-	-
6A Bell Push with Indicator	X1085WH	632	20	-	-	-
Sockets						
6A 3-Pin Socket Outlet with Shutter (BIS)	X2005WHNS	447	10	AAKY2005NS	540	10
6A/16A 3-Pin Socket Outlet with Shutter	X2106WH	690	10	AAKY2106	821	10
Fan Regulators & Dimmers						
Step Fan Regulator (1M)	X3100CMWH	1101	10	-	-	-
Step Type Fan Regulator (2M)	X3200WHCM	1588	5	-	-	-
Dimmer 400W (1M)	X3104WH	1471	10	-	-	-
Dimmer 400W (2M)	X3004WH	2288	5	-	-	-
USB Chargers						
2 Gang USB Charger - 2.1A (2M)	X7003WH	4345	15	-	-	-
Accessories						
RJ11 Telephone outlet with shutter	X4011WH	374	10	-	-	-
RJ45 Data Outlet with shutter	X4045WH	1288	20	-	-	-
TV Socket	X4500WH	350	10	-	-	-
RJ45 Cover for Key Stone Type	X4050WH	519	10	-	-	-
Buzzer	X3300WH	1679	2	-	-	-
Blank off unit (1M)	X0001WH	97	10	-	-	-
Neon Phase Indicator (Red)	X5001	595	20	-	-	-

Please contact Customer Care Center for Stockable and Non stockable status of references.
*Bold references are MTO reference.

Opale - Switches with Satin Finish



AAKX6006



AAKX6005

Description	Reference	Unit MRP [₹]	Pack
Hotel Series*			
Key Tag Switch (Mechanical Type 20 A)	AAKX6005	2162	1
Shaver Socket	AAKX6006	9538	1

*Available in white colour only



X0703



X0704



X0708

Description	Reference for White	Unit MRP [₹]	Pack	Reference for Coke Grey	Unit MRP [₹]	Pack
Cover Plates						
1-2 M Grid & 1 M Cover Frame	X0701	238	10	AAKY0801	314	10
1-2 M Grid & 2 M Cover Frame	X0702	252	10	-	-	-
3 M Grid & 3 M Cover Frame	X0703	298	10	AAKY0803	363	10
4 M Grid & 4 M Cover Frame	X0704	350	10	-	-	-
6 M Grid & 6 M Cover Frame	X0706	488	5	AAKY0806	583	5
8 M Grid & 8 M Cover Frame - Horizontal	X0708	634	5	-	-	-
8 M Grid & 8 M Cover Frame - Square	X0709	757	5	-	-	-
12 M Grid & 12 M Cover Frame	X0712	898	5	AAKY0812	1354	5
18 M Grid & 18 M Cover Frame	AAKX0718	1171	5	-	-	-

Please contact Customer Care Center for Stockable and Non stockable status of references.

*Bold references are MTO reference.

W.E.F. January 15th, 2026

Unica Pure - Irresistibly Beautiful



Wood



Glass



Metal Rhodium Black



Sandy Beige

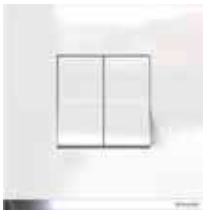

Polar White



Volcanic Grey



Pearl Black



Pewter Grey



Oak

Irresistibly Beautiful

- Authentic finishes - developed from the high quality natural material
- Ingenious Design - Demarcated dolly depicting clear on/off mode of the switch
- Modish Colors - perfectly gel with neutral, accent wall colors and blends perfectly with any decor

Irresistibly Safe & Sturdy

- Self Piercing Terminal - ensuring completely safe, robust and fast installation
- Facile & Guarded Technology - reduces tension in the switch rocker & increases the longevity of the switch
- Plated metal with Plastic over molded Gridplate - Robust, rigid & shock proof gridplate, ensuring durable installation on the metal box

Irresistibly Easy

- Key Hole Feature - Angular and linear adjustments of the gridplate can be easily achieved
- Revolutionary Ease of Mounting with Indicators & Markings

Irresistibly Sustainable

- Green Premium - Complies to HIGHEST INTERNATIONAL STANDARD of Green Certification for manufactured products (RoHS, REACH, PEP, EoLI) and is 100% Recyclable

Irresistibly Innovative

- Future Ready - Features of Voice & Mobile control to fit with smart homes

Irresistibly Versatile

- One Stop Shop - Extensive range covering residential, office, commercial or hospitality
- **Intermediate switches to control multiple 2way switches**

Unica Pure switches with six patented technologies



Life Guarded Sockets

Eliminate possibility of Single Pin Insertion making it extra safe for children

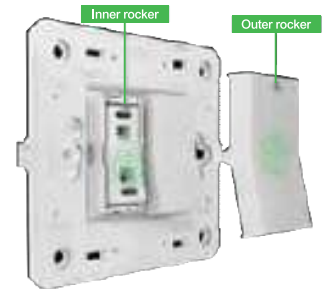

Facile & Guarded Technology

Reduces tension in the switch rocker & increases the longevity of the switch

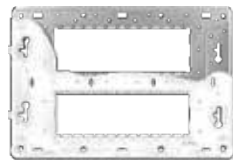

Key Hole Feature

Angular and linear adjustments of the gridplate can be easily achieved



Adjoining (V) Feature Technology

Ensuring perfect alignment of switches

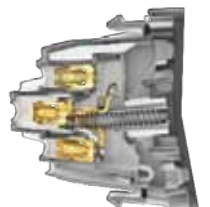

Self-piercing Terminal

Ensuring completely safe, robust and fast installation

Unica Pure - Irresistibly Beautiful



UNS61SW1M_WE



UNS161SWL1M_WE



UNS162MSWL1M_WE



UNS10SW1M_WE



UNS162SW2M_WE



UNSMTSTART2M_WE



UNS616SK2M_WE



UNSSWSO62M_GY



UNSUSBAC2MPDH_WE



UNSACUSB1P1M_WE



UNS5STFAN2M_WE



UNSHDMI_WE



UNSCPTVDIG1M_WE

Description	Reference for Polar White	Unit MRP	Pack	Reference for Volcanic Grey	Unit MRP	Pack
6A Switches						
6AX 1 Way Switch	UNS61SW1M_WE	236	20	UNS61SW1M_GY	273	20
6AX 1 Way Switch With Indicator	UNS61SWL1M_WE	422	20	UNS61SWL1M_GY	483	20
6AX 2 Way Switch	UNS62SW1M_WE	339	10	UNS62SW1M_GY	379	10
10A Intermediate Switches						
10AX Intermediate Switch	UNS10SW1M_WE	1546	1	UNS10SW1M_GY	1865	1
16AX Switches						
16AX 1 Way Switch	UNS161SW1M_WE	391	20	UNS161SW1M_GY	456	20
16AX 1 Way Switch With Indicator	UNS161SWL1M_WE	468	20	UNS161SWL1M_GY	544	20
16AX 2 Way Switch, Polar White	UNS162SW1M_WE	522	10	UNS162SW1M_GY	614	10
16A Master Switch, 2 Way, With Locator & Label	UNS162MSWL1M_WE	1213	20	UNS162MSWL1M_GY	1434	1
16Ax 2 Way 2M Switch	UNS162SW2M_WE	528	10	UNS162SW2M_GY	627	10
16AX~20A 1Way switch with Neon indicator	UNS201SWL1M_WE	464	10	UNS201SWL1M_GY	548	10
Double Pole Switches						
20A Double Pole Switch With Indicator	UNS20DP2M_WE	938	10	UNS20DP2M_GY	1105	1
32A Double Pole Switch With Indicator	UNS32DP2M_WE	1409	10	UNS32DP2M_GY	1687	10
Motor Starter Switch						
Motor Starter	UNSMTSTART2M_WE	2138	10	UNSMTSTART2M_GY	2529	10
Bell Switches						
6A Bellpress, 1M	UNS6BP1M_WE	346	20	UNS6BP1M_GY	406	20
6A Bellpress With Indicator, 1M	UNS6BPL1M_WE	479	20	UNS6BPL1M_GY	573	1
6A Bellpress, 2M, Polar White	UNS6BP2M_WE	478	10	UNS6BP2M_GY	563	1
6A Bellpress With Indicator, 2M	UNS6BPL2M_WE	590	10	UNS6BPL2M_GY	693	1
6A Sockets						
6A 3PIN Sockets outlet with Shutter (BIS)	UNS6SK3P2MNS_WE	495	10	UNS6SK3P2MNS_GY	547	10
6A Switched Socket 2M	UNSSWSO62M_WE	723	10	UNSSWSO62M_GY	796	10
6/16A Sockets						
6/16A Socket	UNS616SK2M_WE	582	10	UNS616SK2M_GY	723	10
USB Chargers						
2.1A 5V USB Charger, 2 Module	UNS21USB2P2M_WE	3596	10	UNS21USB2P2M_GY	4250	1
2.1A 5V USB Charger, 1 Module	UNS21USB1P1M_WE	2472	20	UNS21USB1P1M_GY	2932	20
2.4A 5V A+C USB Charger, 1 Module	UNSACUSB1P1M_WE	3807	10	UNSACUSB1P1M_GY	4281	10
USB A+C 21W PDH 2M WE	UNSUSBAC2MPDH_WE	6027	10	UNSUSBAC2MPDH_GY	6630	10
Blank Plates						
Single Module Blank Plate	UNSBLANK1M_WE	85	20	UNSBLANK1M_GY	95	20
Fan Regulators						
4 Steps 360 Deg Fan Regulator, 1M	UNS4STFAN1M_WE	1025	20	UNS4STFAN1M_GY	1187	20
5 Steps 360 Deg Fan Regulator, 2M	UNS5STFAN2M_WE	1631	10	UNS5STFAN2M_GY	1841	10
Emergency Light Indicator						
Emergency Light Module*	UNSEMERGENCY2M_WE	12742	1	-	-	-
Network, Connectivity & Media Series						
RJ 11 (WITH Shutter)	UNSRJ11_1M_WE	330	20	UNSRJ11_1M_GY	388	20
RJ 45 (WITH Shutter), Cat 6	UNSRJ45_1M_WE	1201	20	UNSRJ45_1M_GY	1391	20
TV Socket Coaxial	UNSTVCOAX1M_WE	346	20	UNSTVCOAX1M_GY	410	20
Volume Control	UNSVOLCTRL2M_WE	2763	10	UNSVOLCTRL2M_GY	3294	10
HDMI	UNSHDMI_WE	2368	20	UNSHDMI_GY	2671	20
TV Socket Digital (F-Connector)	UNSCPTVDIG1M_WE	392	1	-	-	-
PIR Motion Sensor*	UNSPIR_WE	11461	4	-	-	-

Please contact Customer Care Center for Stockable and Non stockable status of references.
*Bold references are MTO reference.

Unica Pure - Irresistibly Beautiful



UNSEKCSW_WE



UNSSHAVER_WE



UNSSKTLT2M_WE



UNFLVPB1M1G_WE



UNSPHASEG1M



UNSCURTAINSW2M_WE



UNSPIR_WE



UNFLVPB1M2G_WE



UNSPHASER1M

New

Description	Reference for Polar White	Unit MRP [₹]	Pack	Reference for Volcanic Grey	Unit MRP [₹]	Pack
Hotel Series*						
Cord Outlet	UNSCORD1M_WE	460	20	UNSCORD1M_GY	511	20
DND / MMR Indicator*	UNSDM1M	3763	20	-	-	-
DND/MMR Indicator v.2	UNSDM1M_WE	1880	-	UNSDM1M_GY	2148	-
DND Switch	UNSDNDSW1M_WE	636	10	UNSDNDSW1M_GY	776	10
MMR Switch	UNSMRWSW1M_WE	636	10	UNSMRWSW1M_GY	776	10
SW DND MMR with interlock	UNSDNDMMRWSW2M_WE	1060	10	UNSDNDMMRWSW2M_GY	1271	10
Electronic Keycard Switch, White	UNSEKCSW_WE	8462	5	UNSEKCSW_GY	9781	5
Electronic Keycard Switch, Sandy Beige	UNSEKCSW_CL	8839	5	UNSEKCSW_CD	8721	5
Curtain Control Switch	UNSCURTAINSW2M_WE	1163	10	UNSCURTAINSW2M_GY	1348	10
Shaver Socket	UNSSHAVER_WE	8834	1	UNSSHAVER_GY	9634	1
Skirt Light with LED, 2M	UNSSKTLT2M_WE	1550	10	UNSSKTLT2M_GY	1814	10
Door Chime 230V AC 2M	UNSICHIME2M_WE	1619	-	UNSICHIME2M_GY	1776	-
Modular ELV Push Button						
1 Gang ELV Switch	UNFLVPB1M1G_WE	1468	-	UNFLVPB1M1G_GY	1468	-
2 Gang ELV Switch	UNFLVPB1M2G_WE	2563	-	UNFLVPB1M2G_GY	2563	-

* Fully compatible with Miluz & Unica Pure

Description	Reference	Unit MRP [₹]	Pack
LED Phase Indicator			
LED Phase Indicator, Red	UNSPHASER1M	570	20
LED Phase Indicator, Green	UNSPHASEG1M	570	20
LED Phase Indicator, Yellow	UNSPHASEY1M	570	20

Please contact Customer Care Center for Stockable and Non stockable status of references.

*Bold references are MTO reference.

W.E.F. January 15th, 2026

Unica Pure - Irresistibly Beautiful



UNPGP2M



UNPGP6M

Description	Reference for Gridplate	Unit MRP [₹]	Pack
Cover Plates			
2 Module Gridplate (Fixing Frame) Only	UNPGP2M	192	4
3 Module Gridplate (Fixing Frame) Only	UNPGP3M	234	9
4 Module Gridplate (Fixing Frame) Only	UNPGP4M	270	8
6 Module Gridplate (Fixing Frame) Only	UNPGP6M	367	9
8 Module Gridplate (Fixing Frame) Only, Linear	UNPGP8ML	378	9
8 Module Gridplate (Fixing Frame) Only, Square	UNPGP8MSQ	484	6
12 Module Gridplate (Fixing Frame) Only	UNPGP12M	565	6



UNPSP2M_WD



UNPSP6M_WD

Description	Reference for Oak Wood	Unit MRP [₹]	Pack
Cover Plates			
1 Module Wood Cover Frame Only	UNPSP1M_WD	2756	6
2 Module Wood Cover Frame Only	UNPSP2M_WD	2929	6
3 Module Wood Cover Frame Only	UNPSP3M_WD	3626	6
4 Module Wood Cover Frame Only	UNPSP4M_WD	4196	6
6 Module Wood Cover Frame Only	UNPSP6M_WD	5987	3
8 Module Wood Cover Frame Only, Linear	UNPSP8ML_WD	7276	3
8 Module Wood Cover Frame Only, Square	UNPSP8MSQ_WD	8679	6
12 Module Wood Cover Frame Only	UNPSP12M_WD	11604	6



UNPSP2M_GW



UNPSP6M_GW



UNPSP2M_GB



UNPSP6M_GB

Description	Reference for Aqua Glass	Unit MRP [₹]	Pack	Reference for Pearl Black Glass	Unit MRP [₹]	Pack
Cover Plates						
1 Module Aqua Glass Cover Frame Only	UNPSP1M_GW	1524	6	UNPSP1M_GB	1804	6
2 Module Aqua Glass Cover Frame Only	UNPSP2M_GW	1714	6	UNPSP2M_GB	2029	6
3 Module Aqua Glass Cover Frame Only	UNPSP3M_GW	1930	6	UNPSP3M_GB	2206	6
4 Module Aqua Glass Cover Frame Only	UNPSP4M_GW	2017	6	UNPSP4M_GB	2391	6
6 Module Aqua Glass Cover Frame Only	UNPSP6M_GW	3644	3	UNPSP6M_GB	4258	3
8M Aqua Glass Cover Frame Only, Linear	UNPSP8ML_GW	4141	3	UNPSP8ML_GB	4878	3
8M Aqua Glass Cover Frame Only, Square	UNPSP8MSQ_GW	5245	6	UNPSP8MSQ_GB	6181	6
12 Module Aqua Glass Cover Frame Only	UNPSP12M_GW	6536	6	UNPSP12M_GB	7692	6

Please contact Customer Care Center for Stockable and Non stockable status of references.
*Bold references are MTO reference.

Unica Pure - Irresistibly Beautiful



UNPSP2M_ML



UNPSP6M_ML

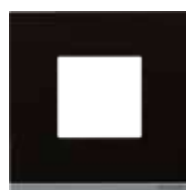

UNPSP2M_MD



UNPSP6M_MD

Description	Reference for Pewter Grey Metal	Unit MRP [₹]	Pack	Reference for Black Metal	Unit MRP [₹]	Pack
Cover Plates						
1 Module Pw Grey Metal Cover Frame Only	UNPSP1M_ML	2723	6	UNPSP1M_MD	2723	6
2 Module Pw Grey Metal Cover Frame Only	UNPSP2M_ML	3022	6	UNPSP2M_MD	3022	6
3 Module Pw Grey Metal Cover Frame Only	UNPSP3M_ML	3440	6	UNPSP3M_MD	3440	6
4 Module Pw Grey Metal Cover Frame Only	UNPSP4M_ML	3616	6	UNPSP4M_MD	3616	6
6 Module Pw Grey Metal Cover Frame Only	UNPSP6M_ML	6403	3	UNPSP6M_MD	6403	3
8Module Pw Grey Metal CF Only, Linear	UNPSP8ML_ML	7214	3	UNPSP8ML_MD	7214	3
8 Module Pw Grey Metal CF Only, Suare	UNPSP8MSQ_ML	9163	6	UNPSP8MSQ_MD	9163	6
12Module Pw Grey Metal Cover Frame Only	UNPSP12M_ML	11367	6	UNPSP12M_MD	11367	6



UNSCP2M_WE



UNSCP6M_WE



UNSCP2M_GY



UNSCP6M_GY



UNSCP2M_CD



UNSCP6M_CD



UNSCP2M_CL



UNSCP6M_CL

Description	Reference for Molded Polar White	Unit MRP [₹]	Pack	Reference for Molded Volcanic Grey	Unit MRP [₹]	Pack	Reference for Painted Mocha Brown	Unit MRP [₹]	Pack	Reference for Painted Sandy Biege	Unit MRP [₹]	Pack
Cover Plates												
1 Module Plastic Surround and Gridplate	UNSCP1M_WE	267	20	UNSCP1M_GY	379	20	UNSCP1M_CD	511	20	UNSCP1M_CL	520	20
2 Module Plastic Surround and Gridplate	UNSCP2M_WE	298	20	UNSCP2M_GY	425	20	UNSCP2M_CD	570	20	UNSCP2M_CL	590	20
3 Module Plastic Surround and Gridplate	UNSCP3M_WE	340	10	UNSCP3M_GY	484	10	UNSCP3M_CD	664	10	UNSCP3M_CL	662	10
4 Module Plastic Surround and Gridplate	UNSCP4M_WE	359	14	UNSCP4M_GY	517	14	UNSCP4M_CD	694	14	UNSCP4M_CL	694	14
6 Module Plastic Surround and Gridplate	UNSCP6M_WE	626	5	UNSCP6M_GY	893	5	UNSCP6M_CD	1195	5	UNSCP6M_CL	1236	5
8 Module Plastic Surround and Gridplate, Linear	UNSCP8ML_WE	705	5	UNSCP8ML_GY	997	5	UNSCP8ML_CD	1348	5	UNSCP8ML_CL	1373	5
8 Module Plastic Surround and Gridplate, Square	UNSCP8MSQ_WE	911	10	UNSCP8MSQ_GY	1382	10	UNSCP8MSQ_CD	1706	10	UNSCP8MSQ_CL	1706	5
9 Module Plastic Surround and Gridplate	UNSCP9M_WE	1144	5	UNSCP9M_GY	1786	5	-	-	-	-	-	
12 Module Plastic Surround and Gridplate	UNSCP12M_WE	1274	5	UNSCP12M_GY	2240	5	UNSCP12M_CD	2156	5	UNSCP12M_CL	2153	5
16 Module Plastic Surround and Gridplate	UNSCP16M_WE	1568	5	UNSCP16M_GY	2705	5	UNSCP16M_CD	2919	5	UNSCP16M_CL	2919	5
18 Module Plastic Surround and Gridplate	UNSCP18M_WE	1625	1	UNSCP18M_GY	2888	1	UNSCP18M_CD	3128	1	UNSCP18M_CL	3128	1

Please contact Customer Care Center for Stockable and Non stockable status of references.

*Bold references are MTO reference.

Wiring Diagram Unica Pure

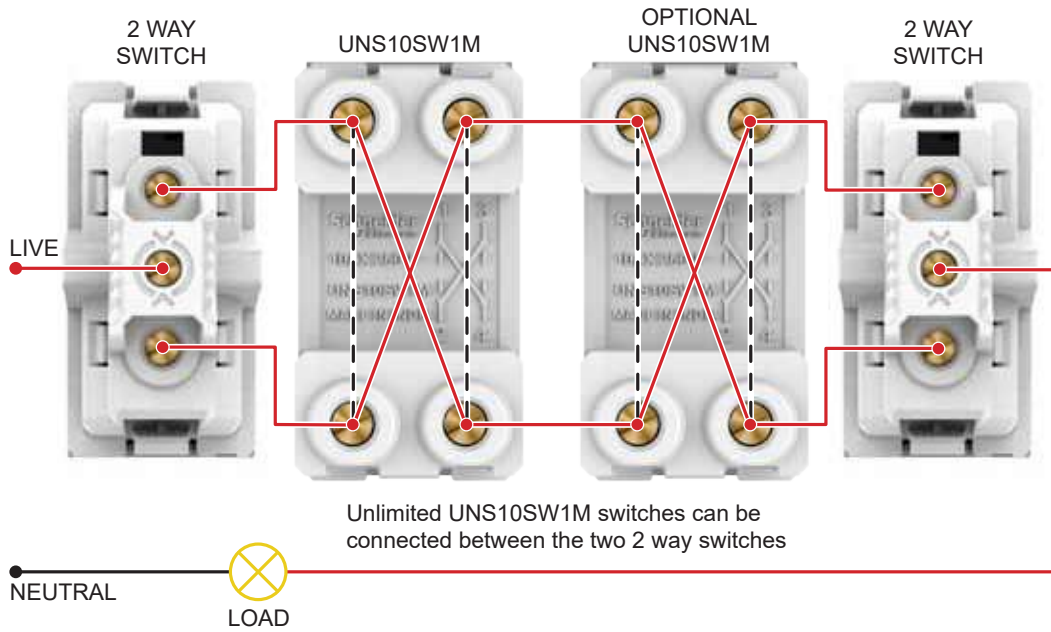

> 10AX Intermediate Switch

UNS10SW1M_WE, UNS10SW1M_GY

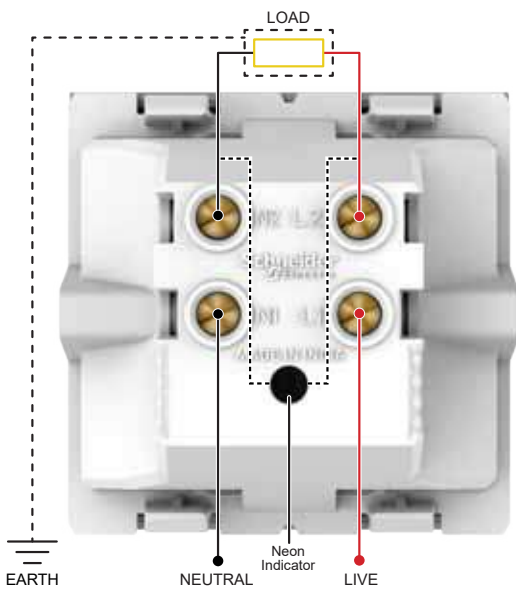

> 20A Double Pole Switch With Indicator

UNS20DP2M_WE, UNS20DP2M_GY

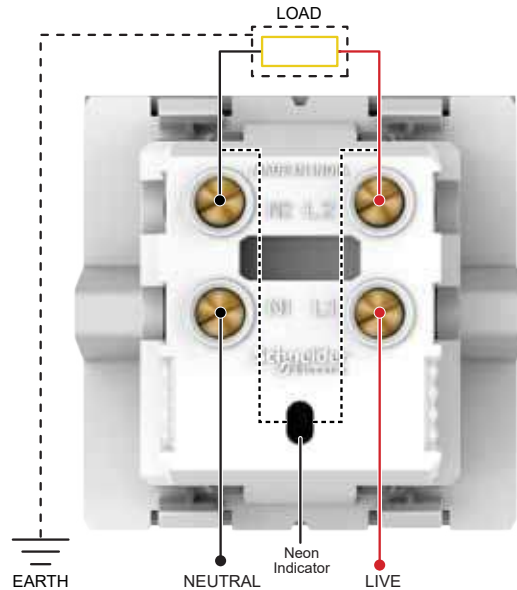

> 32A Double Pole Switch With Indicator

UNS32DP2M_WE, UNS32DP2M_GY

Wiring Diagram Unica Pure

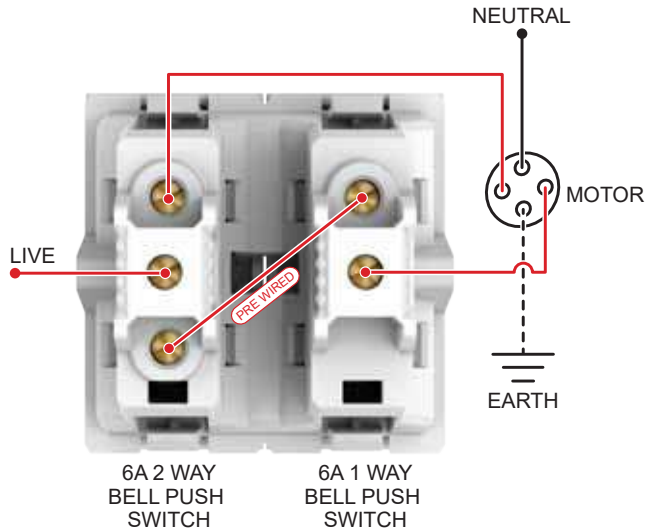

> Curtain Control Switch
UNSCURTAINSW2M_WE

1. Normal Operation

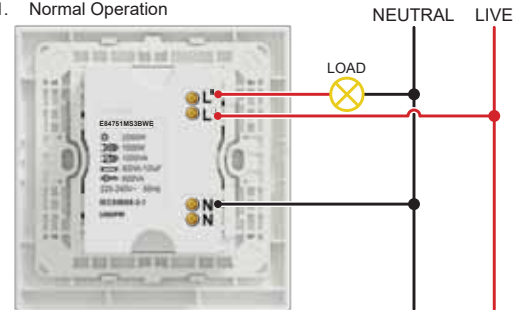

> PIR Motion Sensor*
UNSPIR_WE

2. Two sensors control one load

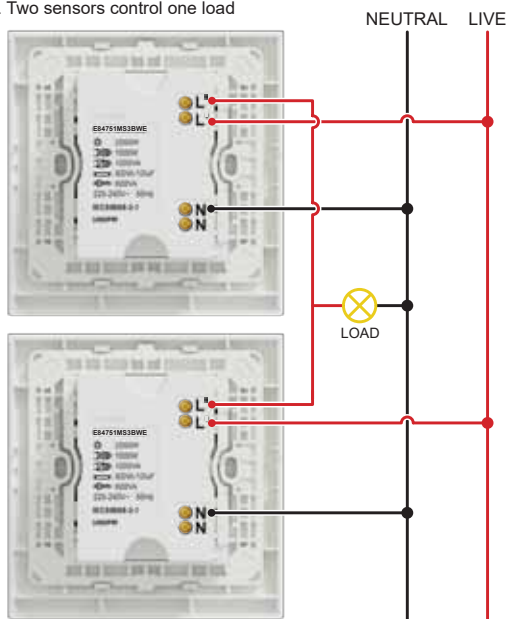

> PIR Motion Sensor*
UNSPIR_WE

3. One sensors control staircase timer (set time knob to 1s)

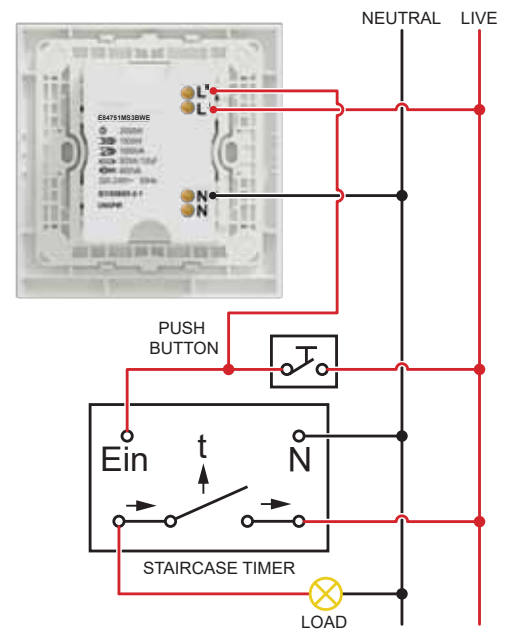

> PIR Motion Sensor*
UNSPIR_WE

Wiring Diagram Unica Pure

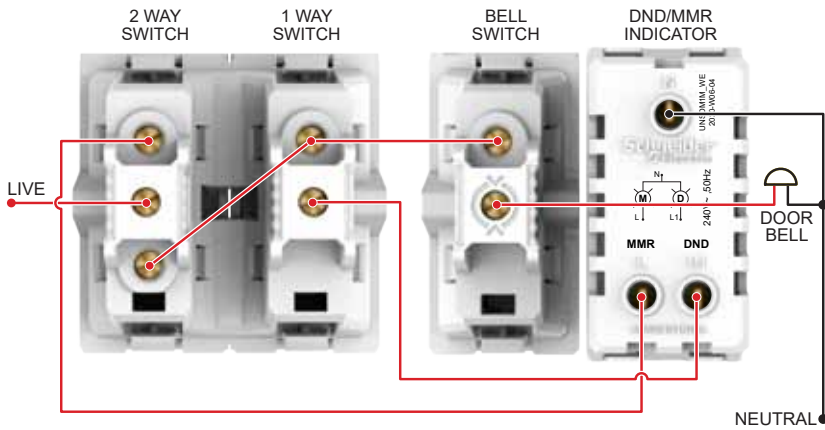

- > DND/MMR Indicator v.2
- > Do Not Disturb Switch
- > Make My Room Switch
- > DND Switch
- > MMR Switch

UNSDM1M_WE, UNSDM1M_GY, UNSDNDSW1M_WE,
UNSDNDSW1M_GY, UNSMMSW1M_WE, UNSMMSW1M_GY

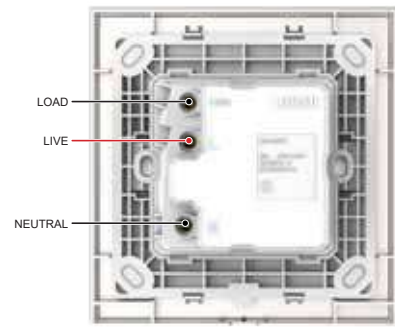

- > Unica Pure Key Card

UNSEKCSW_WE, UNSEKCSW_GY,
UNSEKCSW_CL, UNSEKCSW_CD

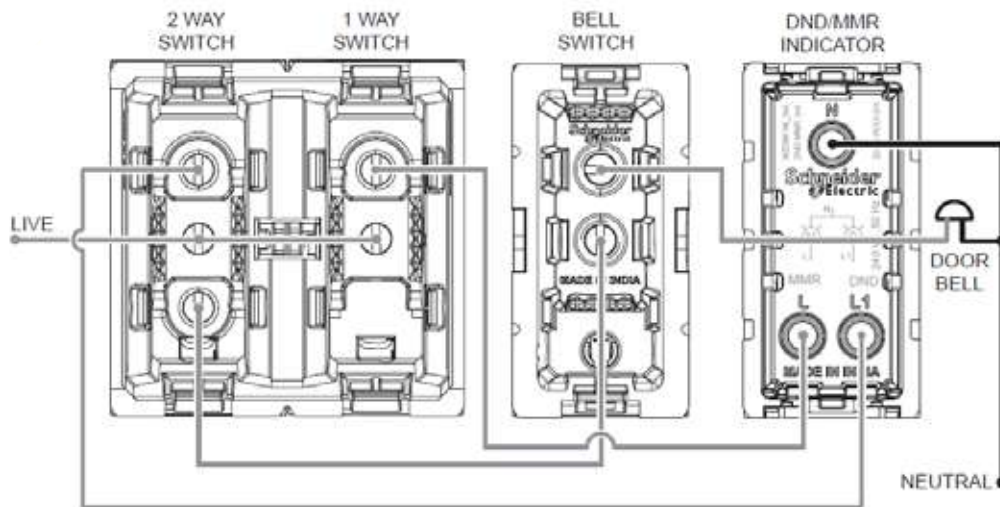

- > SW DNDMMR with interlock

UNSDNDMMRSW2M_WE & UNSDNDMMRSW2M_GY

ZENcelo India - The Revolutionary Full-Flat Switch



- **World's First and only Full-Flat Mechanical Switch**
- **Patented Iso-Motion Technology** - Ensures switch stays in the same position whether On or Off
- **Robust & Strong** - Made of corrosion-resistant, heat-resistant and impact-resistant polycarbonate
- **Safe to Use** - Electric arc encapsulated switches and Data Sockets with patented integrated shutter
- **Designed to Last** - Switches tested to 80,000 times; Sockets tested to 15,000 cycles.
- **Green & Eco Friendly** - RoHS compliant range
- **Dust Proof Cover**
- **All Dark Grey references covered with electrostatic protective film**
- **Intermediate switches to control multiple 2way switches**
- **16AX~20A 1 Way 2G Switch (1M) - IN8444/16: Single switch to control two loads**



Description	Reference for White	Unit MRP [₹]	Pack	Reference for Dark Grey	Unit MRP [₹]	Pack
Switches						
6AX 1 Way switch	IN8401	451	10	IN8401(BZ)	565	10
6AX 1 Way switch (2M)	IN8421	810	10	IN8421(BZ)	959	10
6AX 2 Way switch	IN8402	565	10	IN8402(BZ)	679	10
6AX 1 Way switch with Neon	IN8481	725	10	IN8481(BZ)	868	10
16AX~20A 1 Way switch	IN8401/16	689	10	IN8401/16(BZ)	839	10
16AX~20A 1 Way switch (2M)	IN8421/16	1071	10	-	-	-
16AX~20A 1 Way switch with Neon	IN8481/16	989	10	IN8481/16(BZ)	1171	10
16AX~20A 1 Way switch with Neon (2M)	IN8482/16	1266	10	IN8482/16(BZ)	1504	10
16AX~20A 2 Way switch	IN8402/16	978	10	IN8402/16(BZ)	1268	10
16AX~20A 2 Way switch (2M)	IN8422/16	1171	10	IN8422/16(BZ)	1511	10
16AX~20A 1 Way 2G switch (1M)	IN8444/16	1126	10	IN8444/16(BZ)	1371	10
10AX Intermediate switch	IN8430/IM	1835	10	-	-	-
6A Momentary Switch	IN8487	907	10	IN8487_BZ	1070	-
20A DP Switch with Neon (2M)	IN8486/20	1508	5	IN8486/20(BZ)	2012	5
32A DP Switch with Neon (2M)	IN8486/32	2347	5	IN8486/32(BZ)	2873	5
Motor Starter Switch						
25A Motor Starter switch (2M)	IN8425MS	3933	10	IN8425MS(BZ)	4205	10
Bell Push						
6A Bell Push switch	IN8405	641	10	IN8405(BZ)	792	10
6A Bell Push switch (2M)	IN8425	1041	10	IN8425(BZ)	1262	10
6A Bell Push switch with Neon	IN8485	941	10	IN8485(BZ)	1109	10
6A Bell Push switch with Neon (2M)	IN8486	1101	10	IN8486(BZ)	1389	10
Sockets						
6A 3 PIN Socket Outlet with Shutter (BIS)	IN8426UNS	745	10	IN8426UNS_BZ	902	10
6A/16A 3 Pin Socket with Shutter	IN8426/16	1109	10	IN8426/16(BZ)	1358	10
Fan Regulators & Dimmers						
Fan Control (5 Speeds)	IN84SFR	2712	5	IN84SFR(BZ)	3255	5
Full Flat 500W Dimmer Module (1 Gang)	IN8404D	2464	10	IN8404D(BZ)	2918	10
USB Chargers						
1 Gang USB Charger - 2.1A (1M)	IN8431USB_WE	4296	10	IN8431USB_BZ	4929	10
2.4A 5V A+C USB Charger (1M)	IN8431ACUSB_WE	4749	10	IN8431ACUSB_BZ	5443	10
Accessories						
RJ11 Telephone Outlet with shutter (1 Gang)	IN8431RJS4	733	10	IN8431RJS4(BZ)	903	10
RJ45 Cat6 Data Outlet with shutter	IN8431RJ6	2590	10	IN8431RJ6(BZ)	3163	10
TV Socket	IN8431TV	560	10	IN8431TV(BZ)	721	10
Foot Lamp with White LED (2M)	IN8490FLW	5223	10	-	-	-
Foot Lamp with Yellow LED (2M)	IN8490FLY	5093	10	-	-	-
Blank off unit (1M)	IN8430X	168	10	IN8430X(BZ)	207	10
Door Chime 230VAC 2M	INCHIME8488	2521	-	INCHIME8488_BZ	2820	-
Hotel Series						
Do Not Disturb Panel	INH8451	3962	10	INH8451(BZ)	4479	10
Make My Room Panel	INH8454	3703	10	INH8454(BZ)	4133	10
Do Not Disturb Switch	INH8452	1967	10	INH8452(BZ)	2171	10
Do Not Disturb Switch (2M)	-	0	-	INH8453(BZ)	2434	10
Make My Room Switch	INH8455	1922	10	INH8455(BZ)	2289	10

Please contact Customer Care Center for Stockable and Non stockable status of references.
*Bold references are MTO reference.

ZENcelo India - The Revolutionary Full-Flat Switch

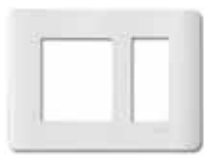

IN8403C

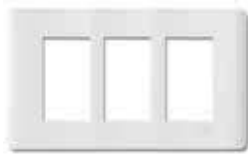

IN8406C



IN8402C(BZ)

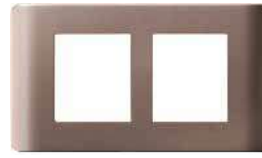

IN8404C(SZ)



IN84012C(SA)

Description	Reference for White	Unit MRP [₹]	Pack	Reference for Dark Grey	Unit MRP [₹]	Pack	Reference for Silver Bronze	Unit MRP [₹]	Pack	Reference for Satin Silver	Unit MRP [₹]	Pack
Cover Plates												
1M Grid & 1M Cover Frame	IN8401C	436	10	IN8401C(BZ)	532	10	IN8401C(SZ)	1250	10	IN8401C(SA)	1332	10
2M Grid & 2M Cover Frame	IN8402C	457	10	IN8402C(BZ)	558	10	IN8402C(SZ)	1237	10	IN8402C(SA)	1357	10
3M Grid & 3M Cover Frame	IN8403C	538	10	IN8403C(BZ)	658	10	IN8403C(SZ)	1521	10	IN8403C(SA)	1668	10
4M Grid & 4M Cover Frame	IN8404C	587	10	IN8404C(BZ)	773	10	IN8404C(SZ)	1827	10	IN8404C(SA)	2006	10
6M Grid & 6M Cover Frame	IN8406C	895	5	IN8406C(BZ)	1098	5	IN8406C(SZ)	2509	5	IN8406C(SA)	2779	5
8M Grid & 8M Cover Frame - Horizontal	IN8408HC	1074	5	IN8408HC(BZ)	1313	5	IN8408HC(SZ)	3422	5	IN8408HC(SA)	3755	5
8M Grid & 8M Cover Frame - Square	IN8408SC	1432	5	IN8408SC(BZ)	2025	5	-	-	-	IN8408SC(SA)	4559	5
9M Grid & 9M Cover Frame	IN8409C	1971	5	-	-	-	IN8409C(SZ)	5745	5	-	-	-
12M Grid & 12M Cover Frame	IN84012C	2375	5	IN84012C(BZ)	2990	5	IN84012C(SZ)	7725	5	IN84012C(SA)	8478	5
18M Grid & 18M Cover Frame	IN84018C	3350	5	IN84018C(BZ)	4426	5	IN84018C(SZ)	10225	5	IN84018C(SA)	11223	5

Please contact Customer Care Center for Stockable and Non stockable status of references.
*Bold references are MTO reference.

W.E.F. January 15th, 2026

Wiring Diagram ZENcelo

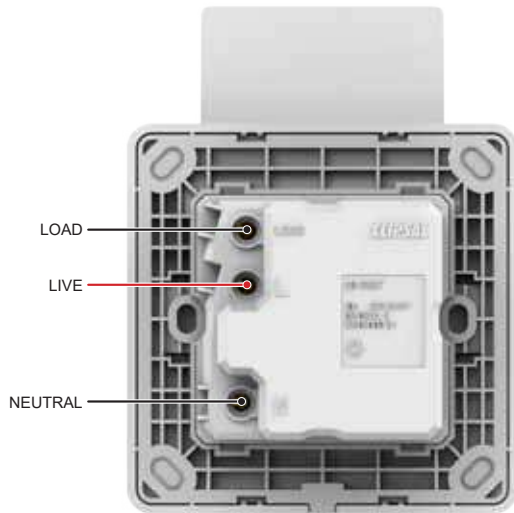

> 16A Electronic Key Card Time Delay
E8431EKT-OS, E8431EKT>SZ-OS

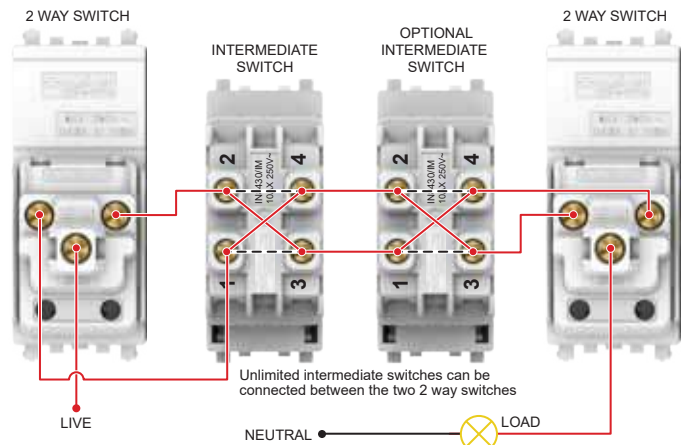

> 10AX Intermediate Switch
IN8430/IM, IN8430/IM (BZ)

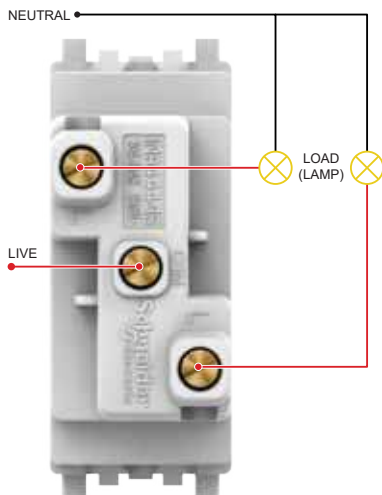

> 16AX~20A 1 Way 2G Switch (1M)
IN8444/16, IN8444/16 (BZ)

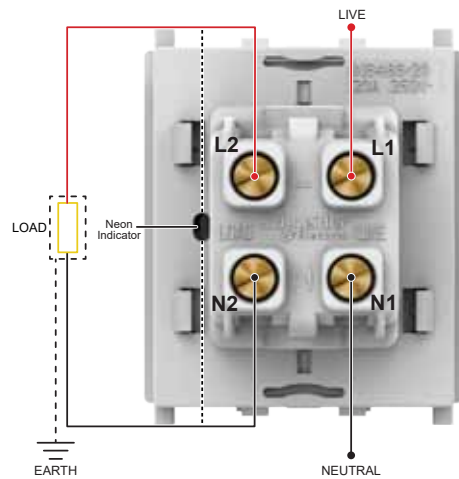

> 20A DP Switch with Neon (2M)
IN8486/20, IN8486/20 (BZ)

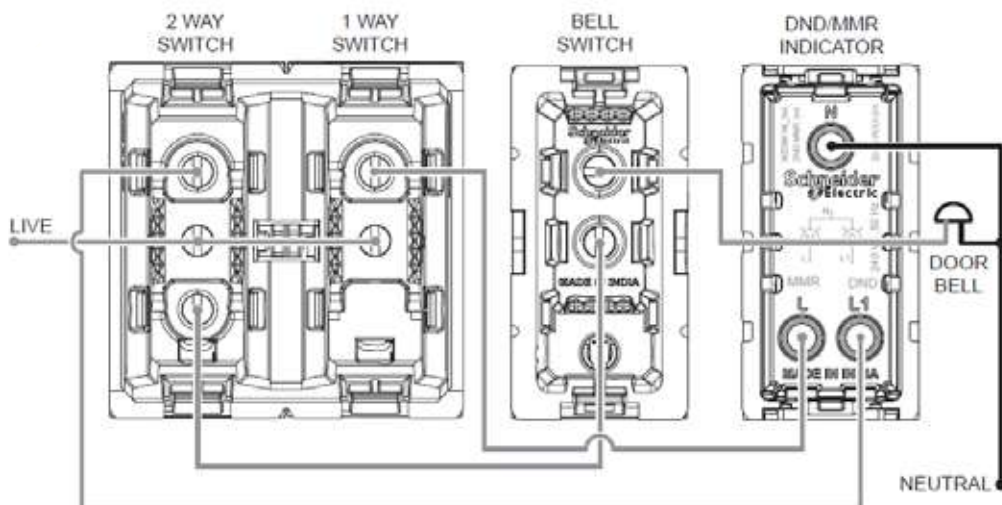

> SW DNDMMR White with interlock 2M
INH8456_WE & INH8456_BZ

Wiring Diagram ZENcelo

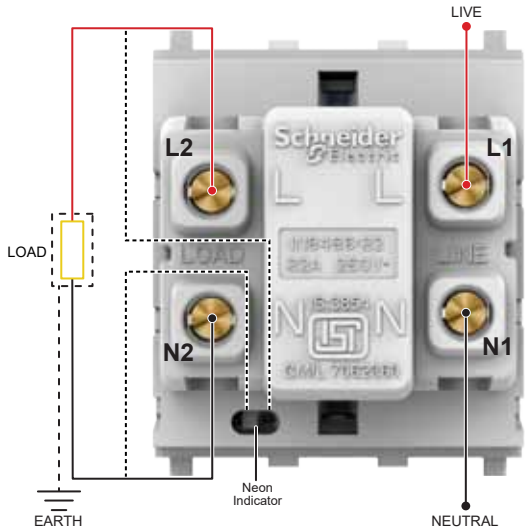

> 32A DP Switch with Neon (2M)

IN8486/32, IN8486/32 (BZ)

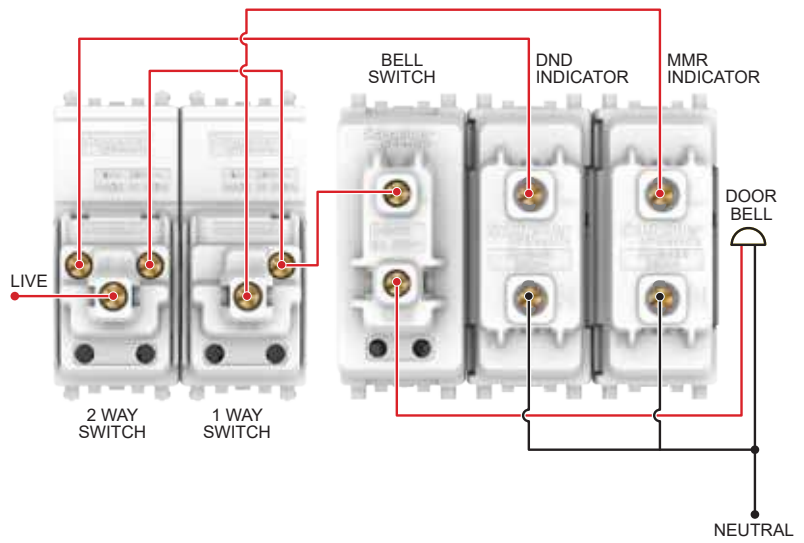

> Do Not Disturb Panel > Make My Room Panel
> Do Not Disturb Switch > Make My Room Switch

INH8451, INH8451 (BZ), INH8454, INH8454 (BZ),
INH8452, INH8452 (BZ), INH8455, INH8455 (BZ)

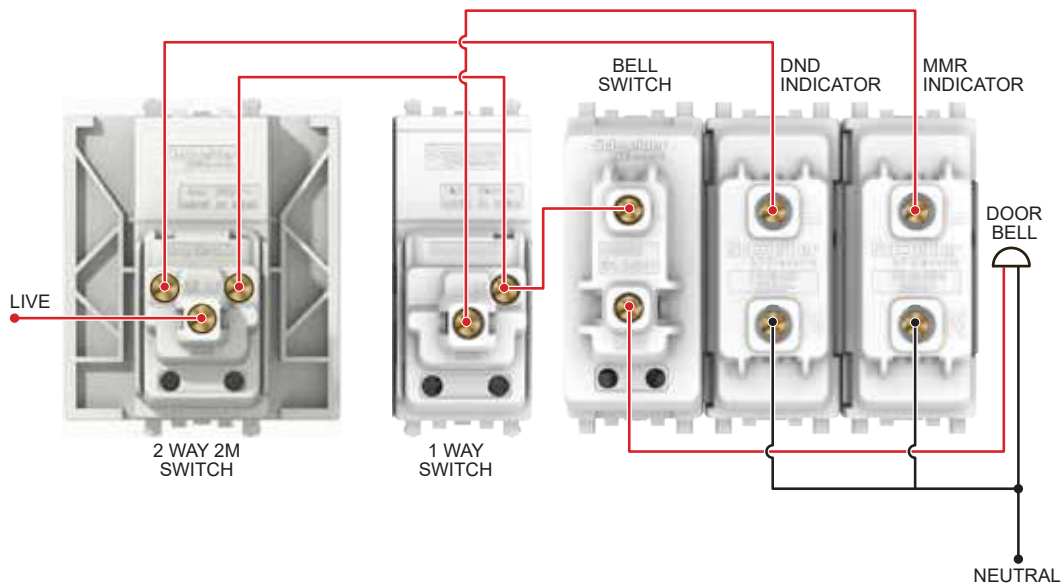

> Do Not Disturb Panel > Make My Room Panel
> Do Not Disturb Switch (2M) > Make My Room Switch

INH8451, INH8451 (BZ), INH8454, INH8454 (BZ)
INH8453 (BZ), INH8455, INH8455 (BZ)

AvatarOn - It's also a Switch



White (WE)



Wine Gold (WG)



Dark Grey (DG)



Dark Wood (WD)



Gold Hairline (GH)



Light Wood (LW)



Award-winning Designs: In 2017, AvatarOn gained international recognition for its innovative design and quality excellence and was awarded the iF Design Award

Ingenious Beauty

- The ground-breaking AvatarOn series is a true marriage of aesthetics and practicality, making it a perfect choice for all home or office designs.

Safe and Reliable

- Our patented "Slim Rocker, Sure Click" SS technology not only gives AvatarOn a greater thinness overall, but also a near-zero contact jitter that reduces sparks, thus ensuring a safe and reliable use.

Customisable Covers for True Adaptability

- AvatarOn switches are available in an array of replaceable covers for full customisation and integration into any home decor. The customised pattern covers of AvatarOn provides you with an extra canvas to showcase your creativity in a subtle yet apparent way.

Modern Look

- The stylish and streamlined design of AvatarOn switch covers are finished in white, soft wood, dark wood and gold hairline materials for a classic look and universal elegance.

Tech-chic Design that Shines

- The AvatarOn soft LED locators merges seamlessly with its sleek giant dolly, creating a stylish and streamlined design and glow with a soft luminescent in the dark, indicating the exact location of each switch at night.

Multifunctional Accessories for Every Day Conveniences



E8331L1_WE_G8



E8331L1_WD_G8



E8331L1LED_WE_G8



E8331L1LED_WD_G8



E8331L2_WE_G8



E8331L2_WD_G8



E8332L1_WE_G8



E8332L1_WD_G8



E8332L2_WE_G8























E8332L2_WD_G8

Product Description	Color	Product Ref. No.	Unit MRP [₹]	Pack
16A Switches (Base + Cover Plate)				
16AX 250V 1 Gang 1 Way Switch	White	E8331L1_WE_G8	654	1
	Wine Gold	E8331L1_WG_G8	983	10
	Dark Grey	E8331L1_DG_G8	983	1
	Metal Gold Hairline	E8331L1_GH_G8	987	10
	Light Wood	E8331L1_LW_G8	1064	10
	Dark Wood	E8331L1_WD_G8	987	10
16AX 250V 1 Gang 1 Way Switch with LED Indicator	White	E8331L1LED_WE_G8	983	1
	Wine Gold	E8331L1LED_WG_G8	1470	10
	Dark Grey	E8331L1LED_DG_G8	1470	1
	Metal Gold Hairline	E8331L1LED_GH_G8	1477	10
	Light Wood	E8331L1LED_LW_G8	1736	10
	Dark Wood	E8331L1LED_WD_G8	1477	10
16AX 250V 1 Gang 2 Way Switch	White	E8331L2_WE_G8	676	1
	Wine Gold	E8331L2_WG_G8	1049	10
	Dark Grey	E8331L2_DG_G8	1049	1
	Metal Gold Hairline	E8331L2_GH_G8	1054	10
	Light Wood	E8331L2_LW_G8	1136	10
	Dark Wood	E8331L2_WD_G8	1054	10
16AX 250V 1 Gang 2 Way Switch with LED Indicator	White	E8331L2LED_WE_G8	1049	10
	Wine Gold	E8331L2LED_WG_G8	1575	10
	Dark Grey	E8331L2LED_DG_G8	1575	1
	Metal Gold Hairline	E8331L2LED_GH_G8	1583	10
	Light Wood	E8331L2LED_LW_G8	1860	10
	Dark Wood	E8331L2LED_WD_G8	1791	10
16AX 250V 2 Gang 1 Way Switch	White	E8332L1_WE_G8	1020	1
	Wine Gold	E8332L1_WG_G8	1531	10
	Dark Grey	E8332L1_DG_G8	1531	1
	Metal Gold Hairline	E8332L1_GH_G8	1546	10
	Light Wood	E8332L1_LW_G8	1612	10
	Dark Wood	E8332L1_WD_G8	1546	10
16AX 250V 2 Gang 1 Way Switch with LED Indicator	White	E8332L1LED_WE_G8	1531	1
	Wine Gold	E8332L1LED_WG_G8	2298	10
	Dark Grey	E8332L1LED_DG_G8	2298	1
	Metal Gold Hairline	E8332L1LED_GH_G8	2321	10
	Light Wood	E8332L1LED_LW_G8	2739	10
	Dark Wood	E8332L1LED_WD_G8	2321	10
16AX 250V 2 Gang 2 Way Switch	White	E8332L2_WE_G8	1242	1
	Wine Gold	E8332L2_WG_G8	1863	10
	Dark Grey	E8332L2_DG_G8	1863	1
	Metal Gold Hairline	E8332L2_GH_G8	1880	10
	Light Wood	E8332L2_LW_G8	2220	10
	Dark Wood	E8332L2_WD_G8	1880	10

Please contact Customer Care Center for Stockable and Non stockable status of references.

*Bold references are MTO reference.

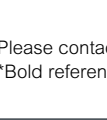
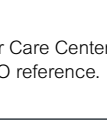
AvatarOn - It's also a Switch

		Product Description	Color	Product Ref. No.	Unit MRP [₹]	Pack
16A Switches (Base + Cover Plate)						
		16AX 250V 2 Gang 2 Way Switch with LED Indicator	White	E8332L2LED_WE_G8	1863	10
			Wine Gold	E8332L2LED_WG_G8	2796	10
			Dark Grey	E8332L2LED_DG_G8	2796	1
			Dark Wood	E8332L2LED_WD_G8	2823	10
		16AX 250V 3 gang 1 Way Switch	White	E8333L1_WE_G8	1683	1
			Wine Gold	E8333L1_WG_G8	2525	10
			Dark Grey	E8333L1_DG_G8	2572	1
			Metal Gold Hairline	E8333L1_GH_G8	2561	10
			Light Wood	E8333L1_LW_G8	2645	10
		16AX 250V 3 gang 1 Way Switch with LED Indicator	Dark Wood	E8333L1_WD_G8	2561	10
			White	E8333L1LED_WE_G8	2525	10
			Wine Gold	E8333L1LED_WG_G8	3785	10
			Dark Grey	E8333L1LED_DG_G8	3785	1
			Metal Gold Hairline	E8333L1LED_GH_G8	3839	10
		16AX 250V 3 gang 2 Way Switch	Light Wood	E8333L1LED_LW_G8	4489	10
			Dark Wood	E8333L1LED_WD_G8	3839	10
			White	E8333L2_WE_G8	1811	1
			Wine Gold	E8333L2_WG_G8	2717	10
		16AX 250V 3 gang 2 Way Switch with LED Indicator	Dark Grey	E8333L2_DG_G8	2717	1
			Metal Gold Hairline	E8333L2_GH_G8	2757	10
			Dark Wood	E8333L2_WD_G8	2757	10
			White	E8333L2LED_WE_G8	2717	10
		16AX 250V 4 Gang 1 Way Switch	Wine Gold	E8333L2LED_WG_G8	4076	10
			Dark Grey	E8333L2LED_DG_G8	4076	1
			Metal Gold Hairline	E8333L2LED_GH_G8	4134	10
			Light Wood	E8333L2LED_LW_G8	4614	10
			Dark Wood	E8333L2LED_WD_G8	4134	10
		16AX 250V 4 Gang 1 Way Switch with LED Indicator	White	E8334L1_WE_G8	2420	1
			Wine Gold	E8334L1_WG_G8	3632	10
			Dark Grey	E8334L1_DG_G8	3632	1
			Metal Gold Hairline	E8334L1_GH_G8	3683	10
			Light Wood	E8334L1_LW_G8	3805	10
		16AX 250V 4 Gang 2 Way Switch	Dark Wood	E8334L1_WD_G8	3683	10
			White	E8334L1LED_WE_G8	3632	10
			Wine Gold	E8334L1LED_WG_G8	5446	10
			Dark Grey	E8334L1LED_DG_G8	5446	1
			Metal Gold Hairline	E8334L1LED_GH_G8	5524	10
		16AX 250V 4 Gang 2 Way Switch with LED Indicator	Light Wood	E8334L1LED_LW_G8	6460	10
			Dark Wood	E8334L1LED_WD_G8	5524	10
			White	E8334L2_WE_G8	2784	1
			Wine Gold	E8334L2_WG_G8	4174	10
			Dark Grey	E8334L2_DG_G8	4254	1
		16AX 250V 4 Gang 2 Way Switch with LED Indicator	Metal Gold Hairline	E8334L2_GH_G8	4235	10
			Dark Wood	E8334L2_WD_G8	4235	10
			White	E8334L2LED_WE_G8	4174	10
			Wine Gold	E8334L2LED_WG_G8	6263	10
		16AX 250V 4 Gang 2 Way Switch with LED Indicator	Dark Grey	E8334L2LED_DG_G8	6263	1
			Metal Gold Hairline	E8334L2LED_GH_G8	6352	10

Please contact Customer Care Center for Stockable and Non stockable status of references.
*Bold references are MTO reference.

AvatarOn - It's also a Switch



E8331M_WE_G8



E8331PRL1_WD_G8



E8332PRL1_WE_G8



E8332PRL1_WD_G8



E8331D20N_WE_G8



E8331D20N_WD_G8



E8331D32N_WE_G8



E8332D20N_WD_G8



E8331D32N_WD_G8





E8331D45N_WD_G8

Product Description	Color	Product Ref. No.	Unit MRP ₹	Pack
16A Intermediate Switches				
16AX 250V 1 Gang Intermediate Switch	White	E8331M_WE_G8	2251	1
	Wine Gold	E8331M_WG_G8	3376	1
	Dark Grey	E8331M_DG_G8	3376	1
10A Momentary Switches				
10A 250V 1 Gang Momentary Switch	Dark Wood	E8331PRL1_WD_G8	1203	10
	White	E8332PRL1_WE_G8	1010	10
	Wine Gold	E8332PRL1_WG_G8	1512	10
	Dark Grey	E8332PRL1_DG_G8	1512	1
	Metal Gold Hairline	E8332PRL1_GH_G8	1512	10
10A 250V 2 Gang Momentary Switch	Dark Wood	E8332PRL1_WD_G8	1512	10
	Dark Wood	E8332PRL1_WD_G8	1512	10
Double Pole Switches				
20A 250V 1 Gang Double Pole Switch with LED Indicator	White	E8331D20N_WE_G8	1732	10
	Wine Gold	E8331D20N_WG_G8	2594	10
	Dark Grey	E8331D20N_DG_G8	2594	1
	Metal Gold Hairline	E8331D20N_GH_G8	2619	10
	Light Wood	E8331D20N_LW_G8	2548	10
	Dark Wood	E8331D20N_WD_G8	2619	10
20A 250V 2 Gang Double Pole Switch with LED Indicator	White	E8332D20N_WE_G8	2205	10
	Wine Gold	E8332D20N_WG_G8	3114	10
	Dark Grey	E8332D20N_DG_G8	3114	1
	Metal Gold Hairline	E8332D20N_GH_G8	3144	10
	Dark Wood	E8332D20N_WD_G8	3144	10
32A 250V 1 Gang Double Pole Switch with LED Indicator	White	E8331D32N_WE_G8	2297	10
	Wine Gold	E8331D32N_WG_G8	3445	10
	Dark Grey	E8331D32N_DG_G8	3445	1
	Metal Gold Hairline	E8331D32N_GH_G8	3477	10
	Light Wood	E8331D32N_LW_G8	3477	10
	Dark Wood	E8331D32N_WD_G8	3477	10
45A 250V 1 Gang Double Pole Switch with LED Indicator	Wine Gold	E8331D45N_WG_G8	4307	10
	Dark Grey	E8331D45N_DG_G8	4385	1
	Metal Gold Hairline	E8331D45N_GH_G8	4427	10
	Dark Wood	E8331D45N_WD_G8	4150	10

Please contact Customer Care Center for Stockable and Non stockable status of references.
*Bold references are MTO reference.

AvatarOn - It's also a Switch

		Product Description	Color	Product Ref. No.	Unit MRP ₹	Pack
Bell Push Switch						
 E8331BPL1_WE_G8	 E8331BPL1_WD_G8	10A 250V Door Bell Push Switch	White	E8331BPL1_WE_G8	733	1
			Wine Gold	E8331BPL1_WG_G8	1102	10
			Dark Grey	E8331BPL1_DG_G8	1097	1
			Metal Gold Hairline	E8331BPL1_GH_G8	1113	10
			Light Wood	E8331BPL1_LW_G8	1123	10
			Dark Wood	E8331BPL1_WD_G8	1113	10
Sockets						
 E8315_6_NS_WE	 E8315_6_NS_WD	6A 2/3 Pin Switched Socket	White	E8315_6_NS_WE	1459	8
			Wine Gold	E8315_6_NS_WG	1890	8
			Dark Grey	E8315_6_NS_DG	1855	1
			Metal Gold Hairline	E8315_6_NS_GH	1873	8
			Light Wood	E8315_6_NS_LW	1944	8
			Dark Wood	E8315_6_NS_WD	1873	8
 E8331FR350_WE_G8	 E8331FR350_WD_G8	6/16A Switched Socket	White	E8315_16_WE	1831	8
			Wine Gold	E8315_16_WG	2328	8
			Dark Grey	E8315_16_DG	2328	1
			Metal Gold Hairline	E8315_16_GH	2395	8
			Light Wood	E8315_16_LW	2440	8
			Dark Wood	E8315_16_WD	2351	8
Fan Regulators						
 E8331_WE	 E8331_WD	5 Steps 360 Deg Fan Regulator	White	E8331FR350_WE_G8	3476	1
			Wine Gold	E8331FR350_WG_G8	4582	1
			Dark Grey	E8331FR350_DG_G8	4582	1
			Metal Gold Hairline	E8331FR350_GH_G8	4582	1
			Light Wood	E8331FR350_LW_G8	4890	1
			Dark Wood	E8331FR350_WD_G8	4582	1
Switch & Socket Covers (Additional)						
 E8331KH_WE	 E8332_WD	1 Gang Switch Cover	White	E8331_WE	199	1
			Wine Gold	E8331_WG	551	1
			Metal Gold Hairline	E8331_GH	667	1
			Dark Wood	E8331_WD	551	1
 E8331KH_WE	 E8332_WD	1 Gang Switch Cover with Keyholder	White	E8331KH_WE	462	1
			White	E8332_WE	300	1
			Wine Gold	E8332_WG	752	1
			Metal Gold Hairline	E8332_GH	752	1
			Light Wood	E8332_LW	755	1
 E8332_WE	 E8333_WE	2 Gang Switch Cover	Dark Wood	E8332_WD	752	1
			White	E8333_WE	464	1
			Wine Gold	E8333_WG	1105	1
			Metal Gold Hairline	E8333_GH	1105	1
			Light Wood	E8333_LW	1084	1

Please contact Customer Care Center for Stockable and Non stockable status of references.
 *Bold references are MTO reference.

AvatarOn - It's also a Switch



E8334_WE



E8334_WD



E8315C_6_NC_WE



E8315C_6_NC_WD



E8332USB_WE_G8



E8315C_16_WD



E8332ACQUSB_WE



E8332USB_WD_G8



E8331_26_WE

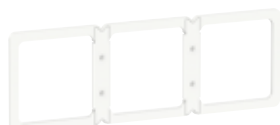

E8331_36_WE



E8331_46_WE



E8330TX_WE

Product Description	Color	Product Ref. No.	Unit MRP ₹	Pack
4G Switch Cover	White	E8334_WE	726	1
	Wine Gold	E8334_WG	1356	1
	Dark Grey	E8334_DG	1295	1
	Metal Gold Hairline	E8334_GH	1506	1
	Light Wood	E8334_LW	1480	1
	Dark Wood	E8334_WD	1356	1
6A 2/3 Pin Switched Socket Cover	White	E8315C_6_NC_WE	518	12
	Wine Gold	E8315C_6_NC_WG	878	12
	Dark Grey	E8315C_6_NC_DG	878	1
	Metal Gold Hairline	E8315C_6_NC_GH	878	12
	Light Wood	E8315C_6_NC_LW	1014	12
	Dark Wood	E8315C_6_NC_WD	878	12
	16A 2/3 Pin Switched Socket Cover	Wine Gold	E8315C_16_WG	918
Dark Grey		E8315C_16_DG	918	1
Metal Gold Hairline		E8315C_16_GH	1019	12
Light Wood		E8315C_16_LW	1011	12
Dark Wood		E8315C_16_WD	1019	12
USB Chargers				
2 x 2.1A USB Charger with Mobile Holder (2.1A with 2 outputs used simultaneously)	White	E8332USB_WE_G8	8716	1
	Wine Gold	E8332USB_WG_G8	13075	1
	Dark Grey	E8332USB_DG_G8	13075	1
	Metal Gold Hairline	E8332USB_GH_G8	13075	1
	Light Wood	E8332USB_LW_G8	15496	1
	Dark Wood	E8332USB_WD_G8	13075	1
	Metal Gold Hairline	E8332ACQUSB_GH	7933	-
21W Type A+C, PD+QC3.0 USB Charger	Light Wood	E8332ACQUSB_LW	8503	-
	Dark Wood	E8332ACQUSB_WD	7933	-
	White	E8332ACQUSB_WE	6413	-
	Wine Gold	E8332ACQUSB_WG	7933	-
	Bracket/Frame (to ensure alignment of switches on 2/3/4 Gang metal box)			
2 Gang Bracket/Frame	White	E8331_26_WE	329	1
	Wine Gold	E8331_26_WG	431	1
	Dark Grey	E8331_26_DG	410	1
3 Gang Bracket/Frame	White	E8331_36_WE	362	1
	Wine Gold	E8331_36_WG	507	1
	Dark Grey	E8331_36_DG	484	1
4 Gang Bracket/ Frame	White	E8331_46_WE	387	1
	Wine Gold	E8331_46_WG	544	1
	Dark Grey	E8331_46_DG	519	1
Blank Plates				
1 Gang Blank Plate	White	E8330X_WE	442	1
	Wine Gold	E8330X_WG	664	1
	Dark Grey	E8330X_DG	664	1
	Metal Gold Hairline	E8330X_GH	695	1
	Dark Wood	E8330X_WD	695	1
2 Gang Blank Plate	White	E8330TX_WE	617	10
	Wine Gold	E8330TX_WG	958	10
	Dark Grey	E8330TX_DG	958	1
	Metal Gold Hairline	E8330TX_GH	1606	10

Please contact Customer Care Center for Stockable and Non stockable status of references.
*Bold references are MTO reference.

AvatarOn - It's also a Switch



E8331BPDMW_WE_G8



E8331KPB_WE



E8332C_WE_G8



E8332C_WD_G8



E83T727V_WE



E83T727V_WD



E8331RJS4_WE



E8331RJS4_WD

Product Description	Color	Product Ref. No.	Unit MRP ₹	Pack
Hotel Series				
DND, PCU, PW Indicator with Bell Switch (Do Not Disturb, Please Clean Up, Please Wait)	White	E8331BPDMW_WE_G8	6347	1
	Wine Gold	E8331BPDMW_WG_G8	9520	10
	Dark Grey	E8331BPDMW_DG_G8	9520	1
16AX 3 Gang Switch with PCU, DND, PW Sym (Do Not Disturb, Please Clean Up, Please Wait)	White	E8333DMWS_WE_G8	6041	1
	Wine Gold	E8333DMWS_WG_G8	8814	10
	Dark Grey	E8333DMWS_DG_G8	9233	1
	Dark Wood	E8333DMWS_WD_G8	9405	10
250V 16A Electronic Keycard Switch	White	E8331EKT_WE	11299	1
	Wine Gold	E8331EKT_WG	16950	1
	Dark Grey	E8331EKT_DG	16949	1
Panic Button with Key Reset	Dark Wood	E8331EKT_WD	17756	1
	White	E8331KPB_WE	2064	1
	Wine Gold	E8331KPB_WG	3033	1
10A 2 Gang Mechanical Curtain Switch	Dark Grey	E8331KPB_DG	2607	1
	White	E8332C_WE_G8	1315	1
	Wine Gold	E8332C_WG_G8	1973	10
	Dark Grey	E8332C_DG_G8	1973	1
	Metal Gold Hairline	E8332C_GH_G8	1973	10
	Light Wood	E8332C_LW_G8	2193	10
	Dark Wood	E8332C_WD_G8	1973	10
115/240V 20VA Universal Version Shaver	White	E83T727V_WE	6271	1
	Wine Gold	E83T727V_WG	10157	1
	Dark Grey	E83T727V_DG	10643	1
	Metal Gold Hairline	E83T727V_GH	10643	1
	Dark Wood	E83T727V_WD	11149	1
Connection Units				
13A 250V 1 Gang Fused Connection with DP Switch and Neon	Wine Gold	E8331DFSGN_WG	5563	10
25A 250V 1 Gang Connection Unit	Metal Gold Hairline	E8331TB_GH	2472	10
Telecom, Network, Connectivity & Media Series				
1 Gang Telephone Socket, Shuttered Wallplate	White	E8331RJS4_WE	977	1
	Wine Gold	E8331RJS4_WG	1629	1
	Dark Grey	E8331RJS4_DG	1629	1
	Metal Gold Hairline	E8331RJS4_GH	1629	1
	Light Wood	E8331RJS4_GH	1629	1
	Dark Wood	E8331RJS4_WD	1629	1

Please contact Customer Care Center for Stockable and Non stockable status of references.
*Bold references are MTO reference.

AvatarOn - It's also a Switch



E8332RJS4_WE



E8331RJS5_WE



E8332RJS5_WE



E8331RJS6_WE



E8332RJS6_WE



E8331TV_WE



E8331TVSF_WE



E8332TDRJS5_WE



E8332TVRJS5_WE



E8332HDUSB_WE



E8332HDHD_WE



E8331RJS_WE



E8332RJS_WE

Product Description	Color	Product Ref. No.	Unit MRP [₹]	Pack
2G Tel Socket, Shuttered Wallplate	White	E8332RJS4_WE	2397	1
	Wine Gold	E8332RJS4_WG	3600	1
1 Gang RJ45 Data Cat5E, Shuttered	White	E8331RJS5_WE	1527	1
	Wine Gold	E8331RJS5_WG	2664	1
	Dark Grey	E8331RJS5_DG	2542	1
	Metal Gold Hairline	E8331RJS5_GH	2542	1
	Dark Wood	E8331RJS5_WD	2664	1
2 Gang RJ45 Data Cat5E, Shuttered	White	E8332RJS5_WE	2792	1
	Wine Gold	E8332RJS5_WG	4656	1
	Dark Grey	E8332RJS5_DG	4444	1
1 Gang RJ45 Data Cat6, Shuttered	Metal Gold Hairline	E8332RJS5_GH	4444	10
	White	E8331RJS6_WE	1825	1
	Wine Gold	E8331RJS6_WG	2736	1
2 Gang RJ45 Data Cat6, Shuttered	Dark Grey	E8331RJS6_DG	2736	1
	White	E8332RJS6_WE	3419	1
	Wine Gold	E8332RJS6_WG	5130	1
1 Gang TV Socket, 75Ω, Through-Connect	Dark Grey	E8332RJS6_DG	5130	1
	White	E8331TV_WE	770	1
	Wine Gold	E8331TV_WG	1283	1
	Dark Grey	E8331TV_DG	1283	1
	Metal Gold Hairline	E8331TV_GH	1283	10
1 Gang TV Socket, Slave 5-1000	Dark Wood	E8331TV_WD	1283	1
	White	E8331TVSF_WE	851	10
	Wine Gold	E8331TVSF_WG	1426	0
1 Gang Tel + RJ45 Data Cat5E, Shuttered	Dark Grey	E8331TVSF_DG	1359	1
	White	E8332TDRJS5_WE	2397	1
	Wine Gold	E8332TDRJS5_WG	3997	1
	Dark Grey	E8332TDRJS5_DG	3816	1
	Metal Gold Hairline	E8332TDRJS5_GH	3816	1
1 Gang TV+ RJ45 Data Cat5E, Shuttered	Dark Wood	E8332TDRJS5_WD	3997	1
	White	E8332TVRJS5_WE	2973	1
	Wine Gold	E8332TVRJS5_WG	4961	1
	Dark Grey	E8332TVRJS5_DG	4734	1
	Metal Gold Hairline	E8332TVRJS5_GH	4734	1
1 Gang TV+ RJ45 Data Cat6, Shuttered	Dark Wood	E8332TVRJS5_WD	5512	1
	White	E8332TVRJS6_WE	2973	1
	Wine Gold	E8332TVRJS6_WG	4961	1
HDMI + USB Socket	Dark Grey	E8332TVRJS6_DG	4734	1
	White	E8332HDUSB_WE	6336	1
	Wine Gold	E8332HDUSB_WG	10559	8
2 Gang HDMI+HDMI, Keystone on Wallplate	Dark Grey	E8332HDUSB_DG	10078	1
	White	E8332HDHD_WE	3475	1
Volume Control, 5W, 8Ohm	Wine Gold	E8331VC_WG	4187	10
	Dark Grey	E8331VC_DG	4187	1
1 Gang S Keystone Wallplate (w/o Mod)	White	E8331RJS_WE	770	10
	Wine Gold	E8331RJS_WG	1155	10
	Dark Grey	E8331RJS_DG	1155	1
2 Gang S Keystone Wallplate (w/o Mod)	White	E8332RJS_WE	1408	10
	Wine Gold	E8332RJS_WG	2111	10
	Dark Grey	E8332RJS_DG	2111	1

Please contact Customer Care Center for Stockable and Non stockable status of references.
*Bold references are MTO reference.

Kavacha - Weather Protected Series



CSW110-GY-EX



A3031WBP_WE

- Pleasing looks with **IP56 protection**
- Large press switch
- Co-moulded sealing with no risk of gasket damage
- Chemical resistant & UV stabilised

Description	Reference	Unit MRP [₹]	Pack
Kavacha IP56 Surface Mount Switches			
Switches with Looping Terminal			
10A 1 Gang 2 Way Switch	CSW110-GY-EX	4397	1
10A 1 Gang 2 Way Bell Press Return Switch	CSW110BPR-GY-EX	4827	1
Kavacha Heavy Duty Isolator Switches			
35A Triple Pole	WHT35-GY-EX	9376	1
63A Triple Pole	WHT63-GY-EX	12075	1
Kavacha IP56 Surface Mount Combined Switched Socket Outlets			
Combination Switch Socket Outlets			
16A Single Pole Switched Socket Outlet	CSC316RP_GY	4872	1
Kavacha IP56 Surface Mount Socket Outlets			
16A Socket Outlet	CSO316RP-GY-EX	3442	1
Kavacha Full-Time Weatherproof Cover			
Full-Time Weatherproof Single Gang Socket Cover (Transparent) IP55	E223R_TR	1246	1
Weatherproof Bell Press Grey	A3031WBP_GY	1903	1
Weatherproof Bell Press White	A3031WBP_WE	1663	1

Please contact Customer Care Center for Stockable and Non stockable status of references.
*Bold references are MTO reference.

Metal Boxes



- **Weld free design** to minimize corrosion and rusting without compromising on strength
- Mounting clip and earth pin designed for **easier installation** and to **avoid loss during transportation**
- Removable side plates and optimized knock outs and for **easier wiring**
- Completely tested & validated as per **IS 14772**

Description	Reference	Unit MRP ₹	Pack
Metal Boxes for Indian Format Ranges (Livia, Opale, Clipsal X, Unica Pure & ZENcelo India)			
0.8 mm thickness			
Metal Box 1 & 2 modules	ME0102	117	20
Metal Box 3 modules	ME0103	153	20
Metal Box 4 modules	ME0104	176	20
1 mm thickness			
Metal Box 1 & 2 modules	MR1102	131	20
Metal Box 3 modules	MR1103	173	20
Metal Box 4 modules	MR1104	199	20
Metal Box 6 modules	MR1106	271	10
Metal Box 8 modules - Horizontal	MR1108	351	10
Metal Box 8 modules - Square	MR1109	351	10
Metal Box 12 module	MR1112	451	5
Metal Box 18 modules	MR1118	536	5

Description	Reference	Unit MRP ₹	Pack
Metal Boxes for BS Format Ranges (AvatarON) - New & Improved Design			
Use Bracket/Frame to ensure alignment of switches on 2/3/4 Gang Metal Box (refer to AvatarOn section for references)			
1 mm thickness			
2 GANG GI Metal Boxes	MM1102	329	20
3 GANG GI Metal Boxes	MM1103	466	20
4 GANG GI Metal Boxes	MM1104	603	20

- Special Metal Box with Gang Partition to accommodate BS format ranges
- Single Metal Box can accommodate up to 4 units
- Number of Gangs for Metal Box = Number of units that it can accommodate (Eg. 3 GANG Metal Box can accommodate up to 3 BS format Units)

Please contact Customer Care Center for Stockable and Non stockable status of references.
*Bold references are MTO reference.

Smart Home Energy Management System



The Future of Homes

It's Time to
Get **Wiser**



Smart Home **Energy Management** System

With the rise of the Internet of Things (IoT), automation has simplified our lives and made our homes smarter. Smart homes, the foundation of smart cities, offer a more secure lifestyle by automating functions and providing greater control over living spaces.

Introducing **Wiser**, the next leap in Home Energy Management. Schneider Electric's vision for a sustainable, connected home of the future enables every device to be easily controlled and personalized through the Wiser Home Application.

Wiser offers an intuitive system with tools to control electricity usage and optimize energy needs without sacrificing comfort. It goes beyond convenience and security, empowering smarter, more sustainable living. Wiser homes focus on people, adding a new dimension to Stylish, Smart, Sustainable and Safe.

Together, we are creating the homes of the future by connecting electricity with digital solutions to help you achieve your sustainability goals.

Home Automation Possibilities



Semi Home Automation

- Lighting Control
- Fan Control
- HVAC Control
- Curtain Control
- Dimming – 10-100%
- Voice, App Control



Full Home Automation

- Mood Creation
- Geo-Fencing
- Digital Door-Lock Integration
- Sensor Based Automation
- Air Quality Management



Safety

- Appliance Protection
- Arc Fault Protection
- Thermal Protection



Home Energy Management

- Energy Monitoring
- Energy Efficiency Features
- Prosumer Management
- NEL Integration



AI / Machine Learning

- Lifestyle Recommendations
- Energy Saving Tips
- Appliance Management Tips



Wiser: One System. Infinite Control.

Make your home **Smart** and **Sustainable** with **Wiser**



SE Ref.	Description of reference	Unit MRP [₹]
CS16A1MSW_WE*	16A 1M Connected Switch, White	7200
CS16A1MSW_GY*	16A 1M Connected Switch, Grey	9450
CD4SFR2M_WE*	4 Step Connected Fan Regulator, White	7500
CD4SFR2M_GY*	4 Step Connected Fan Regulator, Grey	9700
ENMOD1P*	Energy Monitoring Device, Single Phase	On Request
ENMOD3P*	Energy Monitoring Device, Three Phase	On Request
CCIRC1M*	IR Controller- Wi-Fi	On Request
CR2CHRLYPG*	5A 2 Channel Relay Puck- Wi-Fi	On Request
CDWRLY1CH16A*	16A 1 Channel Connected Relay Puck- Wi-Fi	On Request
B1GTEWY*	Multi-Protocol Gateway	On Request
IH100WFVDP*	Smart Doorbell	On Request
IH14000100*	4 Channel Automation Relay	On Request
IH1200010F*	Fan Speed Controller	On Request
IH12000020*	2 Channel Dimmer Controller	On Request
IH101ZW2IR*	ZW_IR Controller	On Request
IH11000200*	2 Channel Curtain Controller	On Request
IH101ZWIFI*	Automation Gateway	On Request

Please contact Customer Care Center for Stockable and Non stockable status of references.

*Bold references are MTO reference.

Surface and Flush Mount Occupancy Sensors



PIR, Ultrasonic Sensors & High Frequency sensor suitable for both Surface & Flush Mount

Description	Reference	Unit MRP [₹]
Surface Mount Single-Load 360 degrees PIR	CSS54E_WE	4099
Flush/Surface Mount Single-Load 360 degrees PIR	SAE-UE-MS-CSAWE	4944
ARGUS Presence Dual-Tech PIR & Ultrasonic Sensor - 1ch	CCT551011	16263
ARGUS Presence Dual-Tech PIR & Ultrasonic Sensor - 2ch	CCT551012	17472
ARGUS IR Remote Controller Dual-Tech	CCT556011	23596
ARGUS Presence High Frequency High Bay Sensor - 2ch	CCT551023	19121
ARGUS IR Remote Controller HF	CCT556023	21631
ARGUS Presence Wide Sense - 2ch	CCT551003	16190
INFRASCAN OUTDOOR 3WIRE 10A	750WPR-GY	25305
INFRASCAN INDOOR 3WIRE 10A	751R-WE	14682
INFRASCAN 360 DEGREE 3WIRE	753R-WE	12381



PIR Flush Mount Sensors

Description	Reference	Unit MRP [₹]
ARGUS Standard min 360° False ceiling indoor movement detector	CCT570005	5786
ARGUS Standard 360° False ceiling indoor movement detector - 2ch	CCT570003	8494
Flush Mount Dual load 360 degrees standalone sensor	SAE-UE-MS-CDBWE	9864



Dimmable Sensors with Light Regulation

Dali Dimmable Sensor

Description	Reference	Unit MRP [₹]
ARGUS Presence Master with IR, DALI	MTN5510-1519	17472

Please contact Customer Care Center for Stockable and Non stockable status of references.
*Bold references are MTO reference.

W.E.F. January 15th, 2026

Wall Mount Sensors



BS Standard & Outdoor IP55 Sensor

Description	Reference	Unit MRP [₹]
Neo C-Metro 200 degrees wall mount sensor, grey colour	E3751MS3C_GS	7881
Zencelo 110 degrees wall mount sensor, white colour	E84751MS3B_WE	7980
Zencelo 90 degrees wall mount sensor, white colour	E84751MS3A_WE	6085
Argus 110 Electronic outdoor movement detector, angle of detection 110 degrees, max. range 12 mtrs, IP55 protection	MTN565119	8518
Argus 220 Electronic movement detector for outdoor ceiling mounting angle of detection 220 degrees, max. range 12 mtrs, IP55 protection	MTN565219	13143

Hotel - ELV Dual Motion Sensor

Description	Reference	Unit MRP [₹]
ELV DUAL TECH MOTION SENSOR	SAE_UE_MS_CULV_WE	10806



Schneider Electric India Pvt. Ltd.

Corporate Office: 15th Floor, DT-4 Downtown, DLF Phase 3, Sector 25A, Gurugram, Haryana - 122002

Ahmedabad

Schneider Electric India (P) Ltd.
1506-1507, 15th Floor Shapth-5
Opp.Karnavati Club, SG Highway,
Ahmedabad, Gujarat - 380015
Tel.: 079-66826701

Bengaluru

Schneider Electric India (P) Ltd.
No. 3/1, JP Techno Park
Mezzanine Floor, Millers Tank Bund
Road, Vasanth Nagar
Bengaluru - 560052
Tel.: 080-71481351

Bhubaneswar

Schneider Electric India (P) Ltd.
Workloop Co-Working in the property
Office No. 316, Esplanade One Mall
Rasulgarh, Bhubaneswar - 751010

Chennai

Schneider Electric India (P) Ltd.
No: 29, 2nd Floor,
Bannari Amman Towers, B-Block
Dr. Radhakrishnan Road, Mylapore
Chennai - 600 004
Tel.:044-71912000

Cochin

Schneider Electric India (P) Ltd.
Alapatt Properties Private Limited
(Trade Name: Centre A)
Main Door Number: 66/4971
(Old Door Number: 40/6584-H)
7th Floor Alapatt Heritage Building
MG Road Kochi - 682035

Coimbatore

Schneider Electric India Pvt. Ltd.
Mikro Grafeo Services Pvt Ltd.,
Elysium Tower, #21, A.TT
Colony, Near Honda Office,
Coimbatore, Tamil Nadu - 641018

Hyderabad

Schneider Electric Pvt. Ltd.
4B-4th Floor, Gumidelli Towers,
Prakash Nagar, Begumpet,
Hyderabad - 500016

Indore

Schneider Electric India (P) Ltd.
219, Dhan Trident Building
Vijay Nagar, A.B.Road
Indore - 452001

Jaipur

Schneider Electric India (P) Ltd.
Jaipur Business Centre 309
3rd Floor, Sangam Tower 190
Church Road, Jaipur - 302001
Tel.: 0141-2374810

Kolkata

Schneider Electric (I) Pvt. Ltd.
BN3, Salt Lake, Sector V,
Kolkata - 700091

Lucknow

Schneider Electric India (P) Ltd.
Summit, Plot No. TCG 3/3
6th Floor, 604A/B/C, Vibhuti Khand
Gomti Nagar, Lucknow
Uttar Pradesh - 226010
Tel.: 0522-3500334

Ludhiana

Schneider Electric India (P) Ltd.
SCO 23, 2nd Floor,
Chandigarh Road, Sector 32
Ludhiana, Punjab -141010
Tel.: 0161- 5203011

Mohali

Schneider Electric India (P) Ltd.
2nd Floor, Tower-A
Bestech Business Tower
Mega Information & Technology Park
Industrial Plot No.1, Phase IX
(Expansion), Mohali - 160059
Tel.: 0172-7198200

Mumbai

Schneider Electric India Pvt. Ltd.
L&T Business Park, Tower B,
7th Floor, TC-II, Gate No.5,
Saki Vihar Road, Powai,
Mumbai - 400072

Nagpur

Schneider Electric India (P) Ltd.
6, Vasant Vihar Complex
W.H.C Road, Shankar Nagar
Nagpur - 440010
Tel.: 0712-2558581

Nashik

Schneider Electric India (P) Ltd.
401, 4th Floor, Rishi Raj Towers
Jehan Circle, Gangapur Road
Nashik - 422013
Tel.: 0253-2344333

New Delhi

Schneider Electric India (P) Ltd.
C-56, Mayapuri Industrial Area, Phase-2
New Delhi - 110064
Tel.: 011-61317400

Pune

Schneider Electric India (P) Ltd.
Amar Caliber, CTS No 911, BMCC Road,
OFF F.C. Road, Deccan Gymkhana,
Shivaji Nagar, Pune - 411007
Tel.: 020-67492500

Vadodara

Schneider Electric India (P) Ltd.
Notus IT Park, 10th Floor, Block-D
Sarabhai Campus, Vadiwadi
Vadodara, Gujarat - 390017

Vishakhapatnam

Schneider Electric India (P) Ltd.
D.N.10-1-43, 1st Floor
Ratnam's Business Centre,
Siripuram Fort, C.B.M.Compound
Visakhapatnam - 530016
Tel.: 0891-6675500

Customer Care Centre

Monday-Saturday, 9 a.m. to 8 p.m.
Toll-free numbers: 1800 419 4272, 1800 103 0011
Email: customer-care.in@schneider-electric.com

For more information, visit our website at: www.se.com/in

- All Prices are in Indian Rupees
- Prices are subject to change without prior notice
- Product evolution is a continuous process and Schneider Electric reserves the right to modify/withdraw any product at any time without prior notice
- Prices charged will be as prevailing on the date of dispatch
- Invoice Amount = (MRP – less Applicable discount) + Applicable GST %
- Tax incidence on invoices is basis applicable GST rates
- Invoice amount not to exceed MRP
- Product pictures shown are for illustration purpose only; actual product may vary
- Kindly refer product datasheet for detailed specification

Distributor