

**Energy
distribution,
Controls &
Wiring
accessories.**

Pricelist with effect from

01st June 2025

:hager

**The reliable
partner for
intelligent
solutions.**

Our vision

Hager Group's vision is to make life on our planet safer, cleaner and more enjoyable through ingenious, sustainable and reliable electrical infrastructure solutions, for all kinds of buildings.

Our world today and tomorrow

We're constantly reimagining electricity in order to meet the world's rising energy demands with better performing and less consuming products and solutions. We're also moving at pace with technology as electricity usage becomes 'smarter' in homes and buildings and yet one thing endures in all this fast-moving change, we will always produce and supply for you safe and simple solutions and products. It's what we have been doing for over 65 years.

Big enough to matter, small enough to care

As a global player, we play in every domain of the electrical infrastructure world; energy distribution, energy management, e-mobility, cable management, wiring accessories, connected and automated homes. We have you covered and our products and solutions are almost always customisable should you desire. We've built a reputation for high quality, scalable and dependable European-made products that are tested, trusted and ready for all types of buildings large and small, so you and your customers can rest assured your installations will endure over the long term.

Generational approach

As a family-owned business that prides itself on being easy to work with, finding solutions in the spirit of collaboration, cooperation and co-creation is how we enjoy working on a daily basis, it's how we feel business is done best and how end results are best achieved together.

Because we're driven by an entrepreneurial flair in a world where people like you matter to us, so much so that we'll be by your side right through your projects and beyond. No matter what, Hager will go the extra mile for you to meet your requirements.

Looking ahead

We are investing on a large scale to ensure you will always get the best from us with huge investments in production capacity and at distribution sites but also developing new and exciting products in our new research and development centres to meet the joint challenges of energy consumption and the environment. As much as the world changes we'll never change our approach to you, our customers, we'll always be with our customary support and learning platforms continuously available for you, with you.

hagergroup

Hager Group is a leading provider of solutions and services for electrical installations in residential, commercial and industrial buildings with 12,900 employees generating € 2.8 Bn in sales (2022). Components and solutions are produced at 20 locations around the globe and are distributed to customers in more than 100 countries.

Members of Hager Group

B.
Berker

ELCOM.

ENERGY STORAGE
E3A DC

B. BOCCHIOTTI

B. IBOCO

On our journey to a sustainable future

At Hager Group, we shape the electric world of tomorrow, a world in which long-term success goes hand in hand with sustainability.

For us, sustainability encompasses Ethics, Employees and the Environment. We call our approach E3. This embraces an ethical approach to business, an inclusive and healthy work environment and reliable products and ingenious solutions which are future-proof. With a strong focus on the environment, we're on the way to making our company a low-carbon operation. We want to take our employees, partners and customers with us on this journey. Let's make better choices together. For our planet and for all generations.

Ethics

We put a strong emphasis on a responsible approach towards business. This approach considers our own employees as well as every person involved in our value chain: from suppliers and their employees, to partners and customers. As we produce electrical equipment and solutions, consumer safety is one of our main concerns, as well as business and data integrity. We are committed to complying with all national and international industry standards and in many instances go above and beyond what is required. Since 2007, we are signatories of the United Nations' Global Compact.



Employees



Recruiting and retaining talent is one of the great challenges of businesses today. For us, a sustainable business is only possible if we can attract the right people who feel welcome and able to fulfil their potential at Hager Group. We see our company as a cross-generational endeavour, much like a family. With life-long learning opportunities and opportunities to build a meaningful career we're offering our employees the ideal basis from which to fully engage in a long-term and fruitful mutual relationship with our company. It goes without saying that diversity and inclusion and equal opportunities are part and parcel of our recruitment policies.

Environment

We are committed to reducing waste and emissions considerably by investing in an environmentally friendly design, the longevity and quality of our products and more sustainable solutions in production and distribution. We perform full life cycle analysis of all our products in the form of a Product Environmental Profile (PEP). At production level,

we are continuously looking for ways to reduce our resources consumption. Currently, 18 of our production facility locations and 4 of our distribution centres are certified to the international environmental management standard ISO 14001, which defines globally recognised requirements for environmental management.



Sustainability certifications for Hager Group:



Member of:
United Nations
Global Compact

When design meets users

Good design contributes to better value for money.

At Hager Group, we take into account the past, the present and the future. But most of all we take into account our customer.

You.



Erwin van Handenhoven,
Hager Group Design Studio
Director

Over time we built up that strong Hager Identity we cherish so much. A community with a feeling of belonging together. A friendly and trustworthy environment where we know that we can count on each other. We endlessly try to improve our offer with deep understanding and respect for our customer. We carefully listen to your messages in order to catch your wishes and, by design, exceed your expectations.

Considering you, our customer, as the centre of our concern and as the starting point of all our projects led us to a new and important initiative: the creation of the Hager Offer Testing Centre. We want you to have the absolutely best customer experience and we wish you to be proud of our brand. So we need your active involvement in our design process. Together we will constantly improve and adapt our offer. Together we shall tackle all future evolutions.

Some of you may see the changes in our business as growing complexity, others might experience it as constant enrichment.

Whatever our feelings may be, it is a fact that today we are merging mechanical, electronic and digital technologies into one coherent electrical infrastructure system. This is why design does not only focusses on best in class Physical devices but also on a clever and useful Digital offer and, most of all, the efficient interplay between both.

Product designers and digital designers are sitting together, thinking together and breathing together. We aim to deploy more and higher level functionalities but reduce complexity for the user, be it a professional or an end-user.

In the light of this ever-growing complexity, we strongly believe in our unique and exciting Hager brand promise: **Safe + Simple**. This is what you should expect from us: well thought-over devices and systems that make life safer and simpler. It is about being safe and feeling safe. It is about making the job easier and comprehensive.

This is the world we are building up for you and with you. This is, we believe, what makes a high quality brand.

Erwin van Handenhoven

“Safe + Simple. (...) It is about being safe and feeling safe. It is about making the job easier and comprehensive. This is the world we are building up for you and with you.”

Finally we wish ‘safe + simple’ to be significant also for our planet. Caring and securing future generations, Sustainability in general, is a serious subject with highest priority on our list. It goes hand in hand with our brand promise and we will not compromise on this. New visions, leading to a specific eco-design ‘made by hager’, are now embedded in our design process.

We are pleased and honoured to design in this thrilling world of electricity that has such a promising future. We kindly thank you for your confidence.



Since its beginning, the Design Studio has been regularly awarded by major international design institutions.



Let's accelerate our energy transition towards more renewables, electric mobility and energy management.



Sabine Busse
Hager Group CEO

Dear customers, partners and friends of Hager Group

We are living through a time of change. The new geopolitical and market environment makes us realise even more how precious our resources are and how important energy is to our way of life.

The recent developments call upon us to further accelerate our energy transition. More renewables, more electric mobility, more energy management. More than ever, we understand what "the future will be electric" really means. This necessary change is a possibility for our industry as a whole.

Energy scarcity makes us appreciate energy efficiency and management in a new way. Our industry plays an essential part in providing the products and solutions to master these challenges. We sit at the heart of shaping the electrical world of tomorrow, a world in which long-term success goes hand in hand with sustainable practices. The current challenges make us all the more determined to ignite this change ourselves - together with our partners and customers.

There is a special strength in pulling together, in finding common ground, in talking to each other and understanding what the other party needs most and how we can support each other. Together, we form a strong network, able to master the challenges ahead of us now and in the future. Of this I am convinced.

I remain optimistic. The challenges are immense. But I don't know of any other industry for which this era of change is such a great opportunity.

We have it in our hands to prove ourselves and to build a great future for our industry.

Yours sincerely,
Sabine Busse

Index

Page

01 Distribution boards

novello+ range / Metal plug & socket outlet accessory / golf / vector /
Busbars and terminals



14-22

02 aptis +

SPN Distribution Board/ Standard TPN Distribution Board/Vertical
TPN Distribution Board/ Vertical TPN distribution Board- MCCB
Incomer/ Flexi Distribution Board/ Phase segregated Distribution
Board



29-34

03 Protection and switching devices

hW ACBs / **h3+** MCCBs / **h3** MCCBs / Power Contactors / Relays /
MPCB / Manual Changeover switches / Automatic transfer switches / ACCL /
h3 MCBs / RCCBs / RCBOs / Accessories / HRC Fuses and Fuse carriers /
Surge protection devices / Isolating switches / Changeover switches /
Multifunction Meter / Voltage Relay & Timer



38-67

04 Energy and lighting control

Indicator lights / Pushbuttons / Modular contactors / Latching relays /
Time switches / Twilight switches / Movement & presence detectors /
Dimmers / Time lag switch/ multi function meter



72-75

05 insysta™ Wiring Accessories

Switches / Push button / Sockets / Regulators & dimmers / Data sockets /
VDI module & accessories / USB socket / / Volume controller /
Cover & grid plates - Plastic / Cover plates - Real material /
Grid plates - Real material / Wall Boxes



78-81

From inception to completion, customized or simple your modern building designs gets delivered with Hager distribution boards.
[#bringinglifetobuildings](#)

Distribution Board

novello+

tried and tested



Type-tested performance to IEC-61439-1 IS 8623-III



Unique ease of mounting with minimal screws



Trusted rigidity and extra durability (IP43, IK09)



Tried flexibility thanks to modular design



01

Page

novello ⁺ SPN	14
novello ⁺ TPN	15
novello ⁺ vertical TPN modular incomer	16
novello ⁺ TPN phase segregated	17
novello ⁺ vertical TPN MCCB incomer	18
novello ⁺ one way enclosures	19
novello ⁺ plug & socket outlets - metal	20
golf enclosures	21
vector enclosures	22



VYS12C

SPN distribution boards

Characteristics:

- Single Door: IP30
- Double Door: IP43 & IP54
- Plain & Acrylic doors
- As per IS 8623 - III
- Impact resistance IK09

- Accessories:
- Wires sets
- Insulated busbars
- Insulated IP2X neutral bars & earth bar
- Blanking plates
- Cable management kit
- Circuit identification labels as standard

IP30 Single Door DBs

Description	Pack Qty.	Cat. Ref.	Unit MRP (₹)
6 way, 6 modules	1	VYS06C	1820
8 way, 8 modules	1	VYS08C	2290
12 way, 12 modules	1	VYS12C	2710
16 way, 16 modules	1	VYS16C	3340
18 way, 18 modules	1	VYS18C	3830



VYS12D

IP43 Double Door DBs

Description	Pack Qty.	Cat. Ref. plain door	Unit MRP (₹)
4 way, 4 modules	1	VYS04D	2410
6 way, 6 modules	1	VYS06D	2710
8 way, 8 modules	1	VYS08D	3000
12 way, 12 modules	1	VYS12D	3600
16 way, 16 modules	1	VYS16D	4580
18 way, 18 modules	1	VYS18D	5020

- IP54 DB's available upon request
- Glazed door DB's available upon request
- Pre-wired and TV telephone DBs available on request.
- For price and technical information, please contact your nearest Hager sales office.



VYT06CH

TPN distribution boards

Characteristics:

- Single Door: IP30
- Double Door: IP43 & IP54
- Plain & Acrylic doors
- As per IS 8623 - III
- Impact resistance IK09
- 8 module Incomer & SP MCBs as O/G

- Accessories:
- Wires sets
- Insulated busbars
- Insulated IP2X neutral bars & earth bar
- Blanking plates
- Cable management kit
- Circuit identification labels as standard

IP30 Single Door DBs
(Incomer + Outgoing Modules)

Description	Pack Qty.	Cat. Ref.	Unit MRP (₹)
4 way, 4+12 modules	1	VYT04CD	4690
6 way, 4+18 modules	1	VYT06CD	5680
4 way, 8+12 modules	1	VYT04CH	5140
6 way, 8+18 modules	1	VYT06CH	6330
8 way, 8+24 modules	1	VYT08CH	7440
12 way, 8+36 modules	1	VYT12CH	11030



VYT06DH

IP43 Double Door DBs
(Incomer + Outgoing Modules)

Description	Pack Qty.	Cat. Ref. metal door	Unit MRP (₹)
4 way, 4+12 modules	1	VYT04DD	5690
6 way, 4+18 modules	1	VYT06DD	6840
4 way, 8+12 modules	1	VYT04DH	5930
6 way, 8+18 modules	1	VYT06DH	7310
8 way, 8+24 modules	1	VYT08DH	8780
12 way, 8+36 modules	1	VYT12DH	13130
16 way, 8+48 modules	1	VYT16DH	16280

Novello+ Distribution Boards



Advantages for you:

- Professional alignment with spirit level
- Reusable & flexible cable management
- Better protection with unique door packaging
- Upgrade to lockable enclosures possible

Standard Accessories:

- Wires sets
- Insulated bus bars
- Insulated neutral bars & earth bar
- blanking plates, Cable management system
- Circuit identification labels

- IP54 DB's available upon request
- Glazed door DB's available upon request
- Pre-wired and TV telephone DBs available on request.
- For price and technical information, please contact your nearest Hager sales office.



VYH04DH

TPN horizontal PPI distribution boards

Characteristics:

- Double Door: IP43 & IP54
- Plain & Acrylic doors
- As per IS 8623 - III
- Impact resistance IK09
- 8 module incomers, 2 module subincomer & SP MCBs as O/G

- Accessories:
- Wires sets
- Insulated busbars
- Insulated IP2X neutral bars & earth bar
- Blanking plates
- Cable management kit
- Circuit identification labels as standard

IP43 Double Door DBs

(Incomer+ Sub Incomer + Outgoing Modules)

Description	Pack Qty.	Cat. Ref. plain door	Unit MRP (₹)
4+2 way, 8+6+12 modules	1	VYH04DH	11200
6+2 way, 8+6+18 modules	1	VYH06DH	13200
8+2 way, 8+6+24 modules	1	VYH08DH	18200
12+2 way, 8+6+36 modules	1	VYH12DH	21850

TPN tier PPI distribution board

Characteristics:

- Double Door: IP43 & IP54
- Plain & Acrylic doors
- As per IS 8623 - III
- Impact resistance IK09
- 8 module incomers, 2 module subincomer & SP MCBs as O/G

- Accessories:
- Wires sets
- Insulated busbars
- Insulated IP2X neutral bars & earth bar
- Blanking plates
- Cable management kit
- Circuit identification labels as standard



VYP10DH

IP43 Double Door DBs

(Incomer+ Sub Incomer + Outgoing Modules)

Description	Pack Qty.	Cat. Ref. plain door	Unit MRP (₹)
6+2 way, 8+6+18 modules	1	VYP06DH	13160
8+2 way, 8+6+24 modules	1	VYP08DH	15520
10+2 way, 8+6+30 modules	1	VYP10DH	16570
12+2 way, 8+6+36 modules	1	VYP12DH	17450
16+2 way, 8+6+48 modules	1	VYP16DH	18960
12+2 way, MCCB*+ 6 + 36 modules	1	VYP12DM	18160

- *Provision to mount frame X160 h3 MCCB
- For P160 h3+ MCCB mounting, please contact your nearest Hager sales office.

- Acrylic door and IP54 DB's, available upon request.
- For price and technical information, please contact your nearest Hager sales office.

Novello+ Distribution Boards

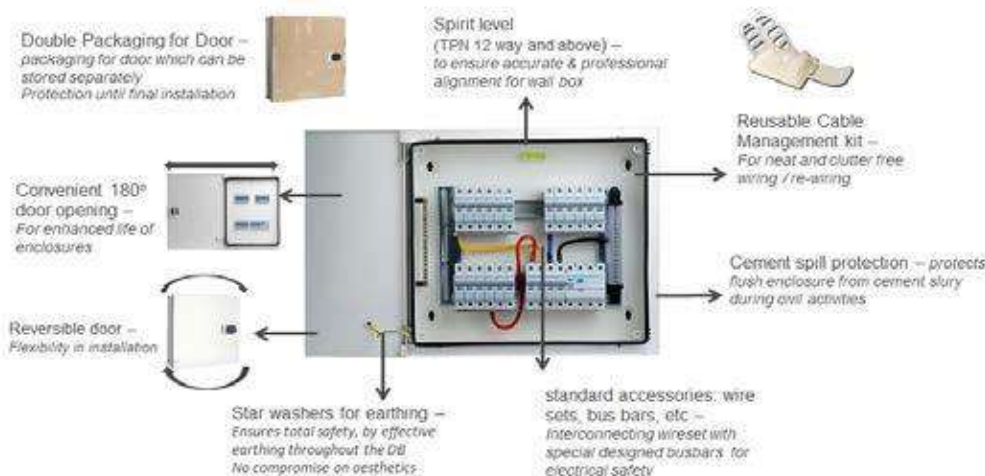



VYV04DL-P

vertical TPN distribution boards (modular incomer)

Characteristics:

- Single Door: IP30
- Double Door: IP43 & IP54
- Plain & Acrylic doors
- As per IS 8623 - III
- Impact resistance IK09
- 12 module incomers, SP/TP MCB's outgoing

- Accessories:
- Interconnection labels
- Blanking plates
- Cable management kit

IP43 Double Door DBs (Incomer + Outgoing Modules)

Description	Pack Qty.	Cat. Ref.	Unit MRP (₹)
4 way, 12+12 modules	1	▶ VYV04DL-P	14730
6 way, 12+18 modules	1	▶ VYV06DL-P	16470
8 way, 12+24 modules	1	▶ VYV08DL-P	18080
12 way, 12+36 modules	1	▶ VYV12DL-P	25450
16 way, 12+48 modules	1	VYV16DL-P	32380

Metering Box

Description	Pack Qty.	Cat. Ref.	Unit MRP (₹)
Ext Box for VTPN DD DB	1	VYV00M	8720

- Acrylic door and IP54 DB's, available upon request.
- For price and technical information, please contact your nearest Hager sales office.

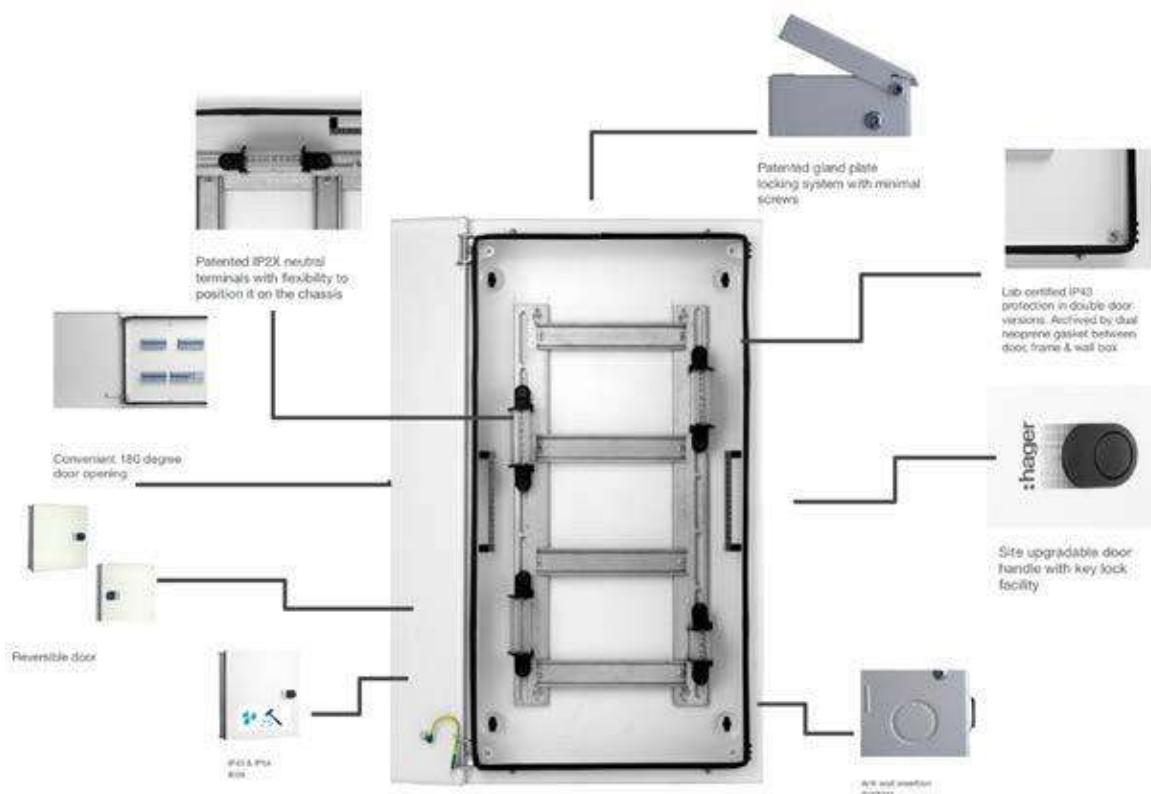



VYV06DM-P

vertical TPN distribution boards (x160 h3 MCCB incomer)

Characteristics:

- Double Door: IP43
- As per IS 8623 - III
- Impact resistance IK09
- X160 frame h3 MCCB incomer & SP/TP MCBs as outgoing
- Accessories:
 - 160A rated busbar
 - Blanking plates
 - Cable management kit
 - Identification labels as standard

**IP43 Double Door DBs
(MCCB + Outgoing Modules)**

Description	Pack Qty.	Cat. Ref.	Unit MRP (₹)
4 way, MCCB+12 modules	1	▶ VYV04DM-P	18240
6 way, MCCB+18 modules	1	▶ VYV06DM-P	20720
8 way, MCCB+24 modules	1	▶ VYV08DM-P	22810
12 way, MCCB+36 modules	1	▶ VYV12DM-P	30510
16 way, MCCB+48 modules	1	VYV16DM-P	36210

vertical TPN distribution boards (P160 h3+ MCCB incomer)

Characteristics:

- Double Door: IP43
- As per IS 8623 - III
- Impact resistance IK09
- P160 frame h3 MCCB incomer & SP/TP MCBs as outgoing
- Accessories:
 - 160A rated busbar
 - Blanking plates
 - Cable management kit
 - Identification labels as standard



VYV06DM-P160

**IP43 Double Door DBs
(MCCB + Outgoing Modules)**

Description	Pack Qty.	Cat. Ref.	Unit MRP (₹)
4 way, MCCB+12 modules	1	VYV04DM-P160	18770
6 way, MCCB+18 modules	1	VYV06DM-P160	21330
8 way, MCCB+24 modules	1	VYV08DM-P160	23480
12 way, MCCB+36 modules	1	VYV12DM-P160	31390
16 way, MCCB+48 modules	1	VYV16DM-P160	37270

vertical TPN distribution boards (x250 h3 / P250 h3+ MCCB incomer)

Characteristics:

- Double Door: IP43
- As per IS 8623 - III
- Impact resistance IK09
- x250 h3 / P250 h3+ frame h3 MCCB incomer & SP/TP MCBs as outgoing
- Accessories:
 - 250A rated busbar
 - Blanking plates
 - Cable management kit
 - Identification labels as standard



VYV06DM2-P

**IP43 Double Door DBs
(MCCB + Outgoing Modules)**

Description	Pack Qty.	Cat. Ref.	Unit MRP (₹)
4 way, MCCB+12 modules	1	VYV04DM2-P	34830
6 way, MCCB+18 modules	1	VYV06DM2-P	37990
8 way, MCCB+24 modules	1	VYV08DM2-P	40630
12 way, MCCB+36 modules	1	VYV12DM2-P	41730
16 way, MCCB+48 modules	1	VYV16DM2-P	48360



VYG08DL

TPN phase segregated distribution boards

Characteristics:

- Single Door: IP30
- Double Door: IP43
- As per IS 8623 - III
- Impact resistance IK09
- Provision for mounting upto 12 module incomer, 4 module sub
- incomer in each phase & SP
- MCBs as outgoing

- Accessories:
- Insulated busbar
- Wire sets
- Insulated IP2X neutral bars & earth bar
- Blanking plates
- Cable management kit
- Identification labels as standard

IP43 Double Door DBs

(Incomer+ Sub Incomer + Outgoing Modules)

Description	Pack Qty.	Cat. Ref. modular incomer	Unit MRP (₹)	Cat. Ref. MCCB incomer*	Unit MRP (₹)
4 way, 12+12+12 modules	1	VYG04DL	14880	VYG04DM	21860
6 way, 12+12+18 modules	1	VYG06DL	16750	VYG06DM	24980
8 way, 12+12+24 modules	1	VYG08DL	18700	VYG08DM	28610
12 way, 12+12+36 modules	1	VYG12DL	23260	VYG12DM	32630

- *Provision to mount X160 frame H3 MCCB



VYC06DH

TPN phase selector distribution boards

Characteristics:

- Single Door: IP30
- Double Door: IP43
- As per IS 8623 - III
- Impact resistance IK09
- 63A rotary switches

- Accessories:
- Wire sets
- Insulated busbars, neutral bars & earth bars
- blanking plates
- Cable management kit
- Identification labels as standard

IP43 Double Door DBs

(Incomer+ Outgoing Modules)

Description	Pack Qty.	Cat. Ref.	Unit MRP (₹)
4 way, 8+12 modules	1	VYC04DH	20870
6 way, 8+18 modules	1	VYC06DH	20870
8 way, 8+24 modules	1	VYC08DH	20870
12 way, 8+36 modules	1	VYC12DH	25570



VYF414D

flexi distribution boards

Characteristics:

- Double Door: IP43 & IP54
- Plain & Acrylic doors
- As per IS 8623 - III
- Impact resistance IK09
- Flexibility to mount incomer & outgoing as per need

- Accessories:
- Blanking plates
- Insulated IP2X neutral bars & earth bar
- Circuit identification labels as standard

IP43 Double Door DBs

(Total Modules)

Description	Pack Qty.	Cat. Ref.	Unit MRP (₹)
2 row, 28 modules	1	VYF214D	8180
3 row, 42 modules	1	VYF314D	10110
4 row, 40 modules	1	VYF410D	9950
4 row, 56 modules	1	VYF414D	10700
4 row, 64 modules	1	VYF416D	12620

- Acrylic door and IP54 DB's, available upon request.
- For price and technical information, please contact your nearest Hager sales office.



VYM04C

one way enclosures

Characteristics:

- IP30 degree of protection

Description	Pack Qty.	Cat. Ref.	Unit MRP (₹)
2 way, 2 modules	1	VYM02C	990
4 way, 4 modules	1	VYM04C	990
6 way, 6 modules	1	VYM06C	1710
8 way, 8 modules	1	VYM08C	1710
metal enclosure hinged door, 3 pole, x160 frame MCCB	1	VYM160HM	3790
metal enclosure hinged door, 4 pole, x160 frame MCCB	1	VYM161HM	3790
metal enclosure hinged door, 3 pole, x250 frame MCCB	1	VYM250HM	9890
metal enclosure hinged door, 4 pole, x250 frame MCCB	1	VYM251HM	9890
160A 3P MCCB h3+ Enclosure	1	VYM160HM-P160	4000
160A 4P MCCB h3+ Enclosure	1	VYM161HM-P160	4000
250A 3P MCCB h3+ Enclosure	1	VYM250HM-P250	10450
250A 4P MCCB h3+ Enclosure	1	VYM251HM-P250	10450
630A 3P MCCB h3+ Enclosure	1	VYM630HM-P630	11300
630A 4P MCCB h3+ Enclosure	1	VYM631HM-P630	11300



VYA220C

plug & socket outlets - metal

Characteristics:

- Supplied with metal plug & socket
- Provision to mount MCBs

- Metal plug & socket: IP30

Description	Pack Qty.	Cat. Ref.	Unit MRP (₹)
10A 2 Pin + SC*, 1 modules	1	VYA110C	2240
20A 2 Pin + SC*, 1 modules	1	VYA120C	2330
20A 2 Pin + SC*, 2 modules	1	VYA220C	2540
20A 3 Pin + SC*, 4 modules	1	VYA420C	3910
32A 3 Pin + SC*, 4 modules	1	VYA432C	5120
63A 5 Pin + SC*, 8 modules	1	VYA863C	17710

* SC - Scraping Earth



VYB432C

plug & socket outlets - plastic

Characteristics:

- Plastic plug & socket:IP54
- Provision to mount MCBs

- Accessories:

- Plastic plug & socket

Description	Pack Qty.	Cat. Ref.	Unit MRP (₹)
16A 3 Pin, 4 modules	1	VYB416C	3640
32A 3 Pin, 4 modules	1	VYB432C	3930
32A 5 Pin, 8 modules	1	VYB832C	7150
63A 5 Pin, 8 modules	1	VYB863C	18000



VZ130I & VZ140I

plug & socket outlets

Characteristics:

- Metal plug & socket:IP44

Description	Pack Qty.	Cat. Ref.	Unit MRP (₹)	Description	Cat. Ref.	Unit MRP (₹)
10A 2P+E Metal Plug	10	VZ130I	320	10A 2P+E Metal Socket	VZ140I	330
20A 2P+E Metal Plug	10	VZ131I	330	20A 2P+E Metal Socket	VZ141I	360
20A 3P+E Metal Plug	10	VZ132I	450	20A 3P+E Metal Socket	VZ142I	490
32A 3P+E Metal Plug	5	VZ133I	800	32A 3P+E Metal Socket	VZ143I	800
63A 5P Metal Plug	1	VZ134I	3650	63A 5P Metal Socket	VZ144I	3870

cable end box for novello⁺ DBs

Characteristics:

- Matt finish
- Powder coated with RAL 9010
- Cable end box suitable for double door DBs.
- Facilitates wiring & wire dressing
- Mounted on top of double door DBs



VYT08E

Description

CEB for SPN DD DBs

Description	Pack Qty.	Cat. Ref.	Unit MRP (₹)
CEB for 4 way SPN DD DB	1	VYS04E	1100
CEB for 6 way SPN DD DB	1	VYS06E	1160
CEB for 8 way SPN DD DB	1	VYS08E	1290
CEB for 12 way SPN DD DB	1	VYS12E	1460
CEB for 16 way SPN DD DB	1	VYS16E	2060
CEB for 18 way SPN DD DB	1	VYS18E	2140

CEB for TPN DD (for 8mod incomer)

CEB for 4 way TPN DD DB	1	VYT04E	1890
CEB for 6 way TPN DD DB	1	VYT06E	2040
CEB for 8 way TPN DD DB	1	VYT08E	3590
CEB for 12 way TPN DD DB	1	VYT12E	4800
CEB for 16 way TPN DD DB	1	VYT16E	4800

CEB for TPN Horizontal PPI DB

CEB for 2 + 4 way Horizontal PPI DD DB	1	VYH04E	1980
CEB for 2 + 6 way Horizontal PPI DD DB	1	VYH06E	3110
CEB for 2 + 8 way Horizontal PPI DD DB	1	VYH08E	3640
CEB for 2 + 12 way Horizontal PPI DD DB	1	VYH12E	4110

CEB for TPNTier PPI DB

CEB for 2 + 6 way Tier PPI DD DB	1	VYP06E	1710
CEB for 2 + 8 way Tier PPI DD DB	1	VYP08E	1740
CEB for 2 + 10 way Tier PPI DD DB	1	VYP10E	2160
CEB for 2 + 12 way Tier PPI DD DB	1	VYP12E	3300
CEB for 2 + 12 way Tier PPI DD DB (MCCB)	1	VYP12EM	3450

CEB for vertical TPN DB

CEB for Vertical TPN DD DB	1	VYV00E	5280
----------------------------	---	---------------	------

CEB for Flexi DB

CEB for 14Mod flexy DB	1	VYF14E	1800
CEB for 16Mod flexy DB	1	VYF16E	2190

Note: DD means double door



VYH08E

Accessories for novello⁺ DBs



VZ100i

Description	Pack Qty.	Cat. Ref.	Unit MRP (₹)
Keylock + 2 keys	10	VZ100i	2150
Door handle for novello ⁺ TPN DB	10	VZ101i	940
Neutral link 5 connection	10	VZ110i	240
Neutral link 9 connection	10	VZ111i	330
Neutral link 15 connection	10	VZ112i	450
Neutral link 19 connection	10	VZ113i	510
4 way 8 Segment cover plate - 4 Mod	5	VZ120i	510
8 way 8 Segment cover plate - 4 Mod	5	VZ121i	620
6 way 8 Segment cover plate - 4 Mod	5	VZ122i	720
12 way 8 Segment cover plate - 4 Mod	5	VZ123i	825



VF312TJ

golf enclosures

Characteristics:

- Double door: IP40
- Flush & surface mounted versions

- Plain & transparent door versions system
- Easy and safe cable management

Flush mounting

Description	Pack Qty.	Cat. Ref. plain door	Cat. Ref. acrylic door	Unit MRP (₹)
1 row 4 modules (4 way SPN DB)	1	VF104PJ	VF104TJ	2100
1 row 8 modules (8 way SPN DB)	1	VF108PJ	VF108TJ	2760
1 row 12 modules (12 way SPN DB)	1	VF112PJ	VF112TJ	3500
1 row 18 modules (18 way SPN DB)	1	VF118PJ	VF118TJ	4440
2 row 24 modules (6 way TPN DB)	1	VF212PJ	VF212TJ	5360
2 row 36modules (8 way TPN DB)	1	VF218PJ	VF218TJ	5550
3 row 36 modules (8 way TPN DB)	1	VF312PJ	VF312TJ	7000
4 row 48 modules (12 way TPN DB)	1	VF412PJ	VF412TJ	8570

Surface mounting

Description	Pack Qty.	Cat. Ref. plain door	Cat. Ref. acrylic door	Unit MRP (₹)
1 row 4 modules (4 way SPN DB)	1	VS104PJ	VS104TJ	2100
1 row 8 modules (8 way SPN DB)	1	VS108PJ	VS108TJ	2760
1 row 12 modules (12 way SPN DB)	1	VS112PJ	VS112TJ	3500
1 row 18 modules (18 way SPN DB)	1	VS118PJ	VS118TJ	4670
2 row 24 modules (6 way TPN DB)	1	VS212PJ	VS212TJ	5360
2 row 36modules (8 way TPN DB)	1	VS218PJ	VS218TJ	7280
3 row 36 modules (8 way TPN DB)	1	VS312PJ	VS312TJ	7000
4 row 48 modules (12 way TPN DB)	1	VS412PJ	VS412TJ	8570



VS412PJ

golf enclosures



Advantages for you:

- Easy mounting - wall box can be turned 180° and has a removable cable entry slide
- More wiring space - between the modular devices and terminals as well as behind the DIN rails
- Clean and convenient wiring - thanks to patented integrated cable management system
- Unbreakable door hinges
- Same door for VS surface mounted version and VF flush mounted version
- Optimised conduit and trunking entries



VE318L

vector enclosures

Characteristics:

- Double door: IP65
- Surface mounted version

- Flexibility to mount incomer & outgoing as per need

Total modules

Description	Pack Qty.	Cat. Ref.	Unit MRP (₹)
1 row 3 modules	1	VE103L	3220
1 row 6 modules	1	VE106L	4000
1 row 10 modules	1	VE110L	5570
1 row 12 modules	1	VE112L	6610
1 row 18 modules	1	VE118L	7870
2 row 24 modules	1	VE212L	8960
2 row 36 modules	1	VE218L	13260
3 row 36 modules	1	VE312L	12140
4 row 48 modules	1	VE412L	17210
3 row 54 modules	1	VE318L	19640
vector IP65 Key lock	1	VZ311	970

Busbars, neutral bars & other accessories for DBs

Characteristics:

- All Insulated busbars are rated for 63A



KDN163A

Fork busbars (for MCBs NBN--N, NCN---N & NDN---N)

Description	Pack Qty.	Cat. Ref.	Unit MRP (₹)
1 pole 1 mod step, 12 mod	100	KDN163A	590
1 pole 1 mod step, 56 mod	50	KD163B	2140
2 pole 2 mod step, 12 mod	50	KDN263A	1000
2 pole 2 mod step, 56 mod	20	KD263B	4230
3 pole 3 mod step, 12 mod	50	KDN363A	1060
3 pole 3 mod step, 57 mod	20	KD363B	5170
4 pole 4 mod step, 12 mod	25	KDN463A	2200
4 pole 4 mod step, 56 mod	10	KD463B	9500

Prong busbars (for MCBs ML---J)

Description	Pack Qty.	Cat. Ref.	Unit MRP (₹)
1 pole 1 step 13 mod - Brown (phase)	1	KB163P	610
1 pole 1 step 13 mod - Blue (neutral)	1	KB163N	610

End caps for busbars

Description	Pack Qty.	Cat. Ref.	Unit MRP (₹)
for 1 pole fork busbar	50	KZN021	40
for 2 & 3 pole fork busbar	10	KZN023	50
for 4 pole fork busbar	10	KZN024	90

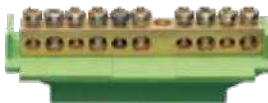

KM14N

Description	Pack Qty.	Cat. Ref.	Unit MRP (₹)
63A din rail mounting neutral link	25	KM14N	620
Half mod blanking plate	50	P031F	40
One mod blanking plate	50	P032F	40

new aptis+



**Spacious
and smart**

:hager

SPN Distribution Board	29
TPN Distribution Board	30
Vertical TPN Distribution Board	31
Vertical TPN distribution Board- MCCB Incomer	32
Flexi Distribution Board	33
Phase segregated Distribution Board	34

aptis+ Distribution Boards: Looks, features, technology- a perfect blend

Innovation is the key driver in our business, bringing clear differentiation in our products. Our solutions exceed the expectations of our customers given the product's ease-of-installation & ease-of-use.



**The new aptis+ enclosure
is primarily designed for
residential applications.**

aptis+, totally redesigned



A sophisticated design

The rounded door edge are just some of the signature features that make the new aptis+ enclosures so distinctive.



aptis+ your enclosure

We collaborated closely with end users to bring you this new version.

:hager

aptis+, a hub of innovation

Discover...

- 01** Quick, easy installation
- 02** Unrivalled accessibility
- 03** Easy wiring: tidier and safer
- 04** More features to make your day-to-day work easier
- 05** Reliable and safe: compliant standard IS/IEC 61439
- 06** RAL9016, powder coated
Door opening angle -180°
Impact resistance – IK09

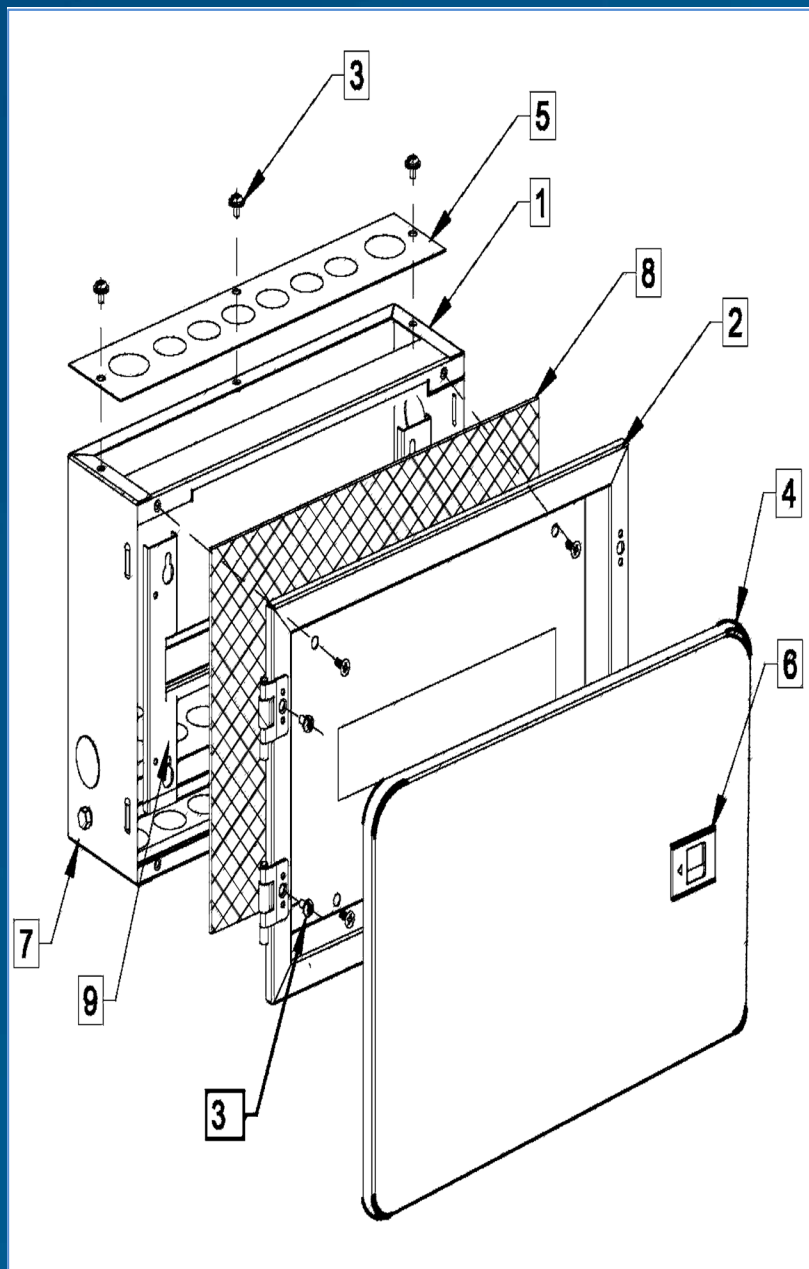

SPN distribution boards

- Metal DBs for single phase & neutral (SPN) supply distribution

Technical data

- Conforms to IS/IEC 61439
- No. of modules – 4, 6, 8, 12, 16, 18 way
- Mounting – Surface / flush mounting
- IP43 for double door
- Material – CRCA sheet steel
- RAL9016

Incoming & outgoing devices

- Incoming : Two pole MCBs / RCBOs / RCCB / Isolator
- Outgoing : SP MCBs as per way

Features & benefits:

- Reversible door with 180 degree opening
- IP2X Neutral terminal
- Cement spill protection
- Anti wall insertion marking
- 100A tin plated insulated copper bus-bar
- Detachable Gland plate at Top & Bottom



Description	Pack Qty.	Cat. Ref.	MRP (₹)
4 way, 4 modules	1	VYS04DN	1930
5 way, 6 modules	1	VYS06DN	2230
8 way, 8 modules	1	VYS08DN	2410
12 way, 12 modules	1	VYS012DN	2780
16 way, 16 modules	1	VYS016DN	3600
18 way, 18modules	1	VYS018DN	3720

TPN Distribution Board Technical Data

- Conforms to IS/IEC 61439
- No. of modules – 4, 6, 8, 12, 16 way
- Mounting – Surface / flush mounting
- IP category
- IP43 for double door
- Material – CRCA sheet steel

Features & benefits:

- Reversible door with 180 degree opening
- IP2X Neutral terminal
- Cement spill protection
- Anti wall insertion marking
- 100A tin plated insulated copper bus-bar
- Detachable Gland plate at Top & Bottom

-RAL 9016

Incoming & outgoing devices

- Incoming : Four pole MCBs / RCBOs / RCCB / Isolator
- Outgoing : SP MCBs as per way up to 63A

Description	Pack Qty.	Cat. Ref.	Unit MRP (₹)
4 way, 8+12 modules	1	VYT04DHN	4,740
6 way, 8+18 modules	1	VYT06DHN	5,900
8 way, 8+24 modules	1	VYT08DHN	7,080
12 way, 8+36 modules	1	VYT12DHN	10,900
16 way, 8+48 modules	1	VYT16DHN	13,670



PPI CONVERSION KIT

Description	Pack Qty.	Cat. Ref.	Unit MRP (₹)
For 4 way TPN DB	1	VYW04EN	3,360
for 6 way TPN DB	1	VYW06EN	3,790
for 8 way TPN DB	1	VYW08EN	4,340
for 12 way TPN DB	1	VYW12EN	4,880
for 16 way TPN DB	1	VYW16EN	5,430

Vertical TPN Distribution Board – Modular incomer

Technical data

- Conforms to IS/IEC 61439
- No. of modules – 4, 6, 8, 12, 16 way
- Mounting – Surface / flush mounting -- IP43 for double door
- Material – CRCA sheet steel
- RAL 9016

Incoming & outgoing devices

- Incoming : I/C 8 module, MCB, RCCB, RCBO
- Outgoing : SP / TP MCB

Features & benefits:

- Reversible door with 180 degree opening
- IP2X Neutral terminal
- Cement spill protection
- Anti wall insertion marking
- Accessory kit
- Detachable Gland plate at Top & Bottom
- 200A copper bus bar

Description	Pack Qty.	Cat. Ref.	Unit MRP (₹)
4 way, 8+12 modules	1	VYV04DLN	11,680
6 way, 8+18 modules	1	VYV06DLN	13,130
8 way, 8+24 modules	1	VYV08DLN	15,230
12 way, 8+36 modules	1	VYV12DLN	20,650
16 way, 8+48 modules	1	VYV16DLN	23,720

Vertical TPN Distribution Board – MCCB incomer (*h3 x160 frame 3P/ 4P MCCB)

Technical data

- Conforms to IIS/IEC 61439
- No. of modules – 4, 6, 8, 12, 16 way
- Mounting – Surface / flush mounting -- IP43 for double door
- Material – CRCA sheet steel
- RAL 9016

Incoming & outgoing devices

- Incoming : I/C 3P/4P MCCB (X160 MCCB) PROVISION-1NO
- Outgoing : SP / TP MCB

Features & benefits:

- Reversible door with 180 degree opening
- IP2X Neutral terminal
- Cement spill protection
- Anti wall insertion marking
- Accessory kit
- Detachable Gland plate at Top & Bottom
- 200A Copper bus

Description	Pack Qty.	Cat. Ref.	Unit MRP (₹)
4 way, MCCB+12 modules	1	VYV04DMN	14,380
6 way, MCCB+18 modules	1	VYV06DMN	15,940
8 way, MCCB+24 modules	1	VYV08DMN	18,170
12 way, MCCB+36 modules	1	VYV12DMN	23,840
16 way, MCCB+48 modules	1	VYV16DMN	27,310

Flexi Distribution Board

Technical data

- Conforms to IS/IEC 61439
- Available in 28, 42, 40, 56 and 64 modules
- Mounting – Surface / flush mounting
- IP43 for double door
- Material - CRCA sheet steel
- RAL 9016

Incoming & outgoing devices

Flexibility to mount incomer and outgoing as per need

Features & benefits:

- Reversible door with 180 degree opening
- IP2X Neutral terminal
- Cement spill protection
- Anti wall insertion marking
- Accessory kit
- Detachable Gland plate at Top & Bottom

Description	Pack Qty.	Cat. Ref.	Unit MRP (₹)
2 row, 28 modules	1	VYF214DN	6,120
3 row, 42 modules	1	VYF314DN	7,330
4 row, 40 modules	1	VYF410DN	7,970
4 row, 56 modules	1	VYF414DN	8,570
4 row, 64 modules	1	VYF416DN	10,110



Distribution Boards

Phase Segregated Distribution Board

Phase Segregated Distribution Board

Technical data

- Conforms to IS/IEC 61439
- No of modules – 4, 6, 8, 12 modules
- Mounting – Surface / flush mounting
- IP43 for double door
- Material - CRCA sheet steel
- RAL 9016

Features & benefits:

- Reversible door with 180 degree opening
- IP2X Neutral terminal
- Cement spill protection
- Anti wall insertion marking
- Accessory kit
- Detachable Gland plate at Top & Bottom

Incoming & outgoing devices

- Incoming : I/C 8 module, MCB, RCCB, RCBO- 1no
- Sub Incoming: 4 Module, RCCB, RCBO- 3no per phase
- Outgoing : O/G SP MCBs

Description	Pack Qty.	Cat. Ref.	Unit MRP (₹)
4 way, 8+12+12 modules	1	VYG04DLN	12,670
6 way, 8+12+18 modules	1	VYG06DLN	14,280
8 way, 8+12+24 modules	1	VYG08DLN	15,930
12 way, 8+12+36 modules	1	VYG12DLN	19,770



Accessories

Description	Pack Qty.	Cat. Ref.	Unit MRP (₹)
Cable end box, VTPN, DD	1	VYV00EN	3,870
Cable end box, TPN, 4 way, DD	1	VYT04EN	1,380
Cable end box, TPN, 6 way, DD	1	VYT06EN	1,500
Cable end box, TPN, 8 way, DD	1	VYT08EN	2,630
Cable end box, TPN, 12 way, DD	1	VYT12EN	3,520
Cable end box, TPN, 16 way, DD	1	VYT16EN	3,520
Cable end box, SPN, 4 way, DD	1	VYS04EN	810
Cable end box, SPN, 6 way, DD	1	VYS06EN	850
Cable end box, SPN, 8 way, DD	1	VYS08EN	940
Cable end box, SPN, 12 way, DD	1	VYS12EN	1,070
Cable end box, SPN, 16 way, DD	1	VYS16EN	1,510
Cable end box, SPN, 18 way, DD	1	VYS18EN	1,570
Cable end box, PSG DB, 4way, DD	1	VYG04EN	1,850
Cable end box, PSG DB, 6way, DD	1	VYG06EN	2,070
Cable end box, PSG DB, 8way, DD	1	VYG08EN	2,300
Cable end box, PSG DB, 12way, DD	1	VYG12EN	3,310
Cable end box, flexy DB, 4 Row 14M	1	VYF14EN	1,320
Cable end box, flexy DB, 4 Row 16M	1	VYF16EN	1,610

Protection Devices

Hager protection devices set the industry standard for reliability, quality and performance. It is the mission of company to provide the highest quality products that clearly set themselves apart from the market. Hager range of modular protection devices comprises of over-current protection, residual current protection, surge protection, over-voltage and under-voltage protection solution.



	Page
hw ACBs	38
h3+ MCCBs thermal magnetic release	41
h3+ MCCBs microprocessor LSI release	42
h3+ MCCBs microprocessor LSIg release	43
h3+ MCCBs microprocessor LSIg energy release	44
h3+ MCCBs accessories	47
h3 MCCBs thermal magnetic release	48
MCCBs trip free switches	49
MCCBs accessories	50
Power Contactor, Overload Relay and MPCB	52
Manual changeover switches	55
MCOS enclosures	55
Automatic transfer switch	56
Automatic changeover with current limiter - SPN	57
Automatic changeover with current limiter - TPN	57
h3 MCBs type NBN, NCN 0.5 to 63 A	58
h3 MCBs type NDN 0.5 to 63 A	59
MCBs type HLF 80 to 125 A	60
Auxilliaris & accessories	61
RCCBs	61
RCCB - type Hi (high immunity)	61
RCBOs - 2 pole 2 modules	62
RCBOs / RCBOs type Hi	60
RCBO, RCD+MCB modules	61
RCD add-on blocks (125A)	64
HRC fuse carriers	64
HRC cartridge fuses gG type	65
Surge protection devices	65
Modular changeover switches	66
Isolating switches	66
Ammeter Led, Spare, Voltage Protection Relay	67

High powered air circuit breakers **hw**

Air Circuit Breakers get their name from the fact that their breaking chambers are in the open air to allow better energy dissipation. Their electrical and mechanical strength, breaking capacity, maintainability and accessories make them ideal for protection for low voltage installations.



Smart.
Safe.
Simple.

:hager

Our new range of **hws** Air Circuit Breakers are designed for maximum safety, reliable performance and installation flexibility to cater to all the customer needs with unmatched performance and following advantages :

- Safety and compliance
- Flexibility and adaptability
- Performance and reliability
- Advanced protection
- Easy installation and use
- Accessories and easy maintenance
- Communication and surveillance





HWBS416EDA

hW Draw-out & Fixed type Air Circuit Breakers 800-5000A

Characteristics:

- Conforms to IEC 60947-2
- Upto 100kA breaking capacity
- Microprocessor based Protection Release with inbuilt ZSI
- Inbuilt terminal adaptor for incoming and outgoing
- Inbuilt Digital Output for Separate Fault Indication standard
- Fully rated Neutral with inbuilt protection

Breaking Capacity Icu=Ics=Icw(1sec)	Rating (A)	3 Pole with LSIG (w/o Display)		4 Pole with LSIG (w/o Display)	
		MDO (₹)	MF (₹)	MDO (₹)	MF (₹)
Frame A - Type H 50kA	630	243190	175310	281950	228350
	800	243190	175310	281950	228350
	1000	245840	194750	304540	237340
	1250	281720	204230	325910	245860
	1600	320190	248470	433890	321170
Frame A - Type N 65kA	2000	415850	291150	501750	380490
	630	290220	200670	330300	260140
	800	290220	200670	330300	260140
	1000	293380	223970	356760	271650
	1250	333060	232670	387230	281410
Frame B - Type N 65kA	1600	378550	285740	457690	369350
	2000	461450	334820	561560	425340
	2500	464690	354910	564610	432080
	3200	566920	507880	690020	604050
4000	693350	625190	862040	755660	

Breaking Capacity Icu=Ics=Icw(1sec)	Rating (A)	3 Pole with LSIG (w/o Display)		4 Pole with LSIG (w/o Display)	
		EDO (₹)	EF (₹)	EDO (₹)	EF (₹)
Frame A - Type H 50kA	630	297240	229360	336000	282400
	800	297240	229360	336000	282400
	1000	299890	248800	358590	291390
	1250	355770	258280	379960	299910
	1600	374240	302520	487940	375220
Frame A - Type N 65kA	2000	469900	345200	555800	434540
	630	344270	254720	384350	314190
	800	344270	254720	384350	314190
	1000	347430	278020	410810	325700
	1250	387110	286720	441280	325460
Frame B - Type N 65kA	1600	432600	339790	511740	423400
	2000	515500	388870	615610	479390
	2500	518740	408960	618660	486130
	3200	620970	561930	744070	658100
4000	747400	679240	916090	809710	

Accessories

Description	Cat. Ref.	Unit MRP (₹)
Shunt Release - DC 24V	HWX501	6900
Shunt Release - AC/DC 110V	HWX503	6900
Shunt Release - AC/DC 220-250V	HWX504	6900
Closing Release - DC 24V	HWX551	6900
Closing Release - AC/DC 110V	HWX553	6900
Closing Release - AC/DC 220-250V	HWX554	6900
Undervoltage Release - AC/DC 110V	HWX513	6900
Undervoltage Release - AC/DC 220-250V	HWX514	6900
Undervoltage Release - AC 380-415V	HWX515	6900
Motor Operator - DC 24V	HWX541	40250
Motor Operator - AC/DC 110V	HWX543	40250
Motor Operator - AC/DC 220-250V	HWX544	40250

Note:

- EDO version of ACB is inclusive of shunt release, closing coil and motor operator MRP

ACB Variants

Description		Unit MRP (₹)
Switch Disconnecter version (without Protection Release)	Reduce	20000
ACB with LSIG + "A" Release (LCD display with Current Metering)	Add	8500
ACB with LSIG + "E" Release (LCD display with Energy Metering)		On Request

Note:

- LP changes for product configuration w.r.t. ACB having LSIG trip unit

hW Air Circuit Breakers

Product codification principle - 18 digits

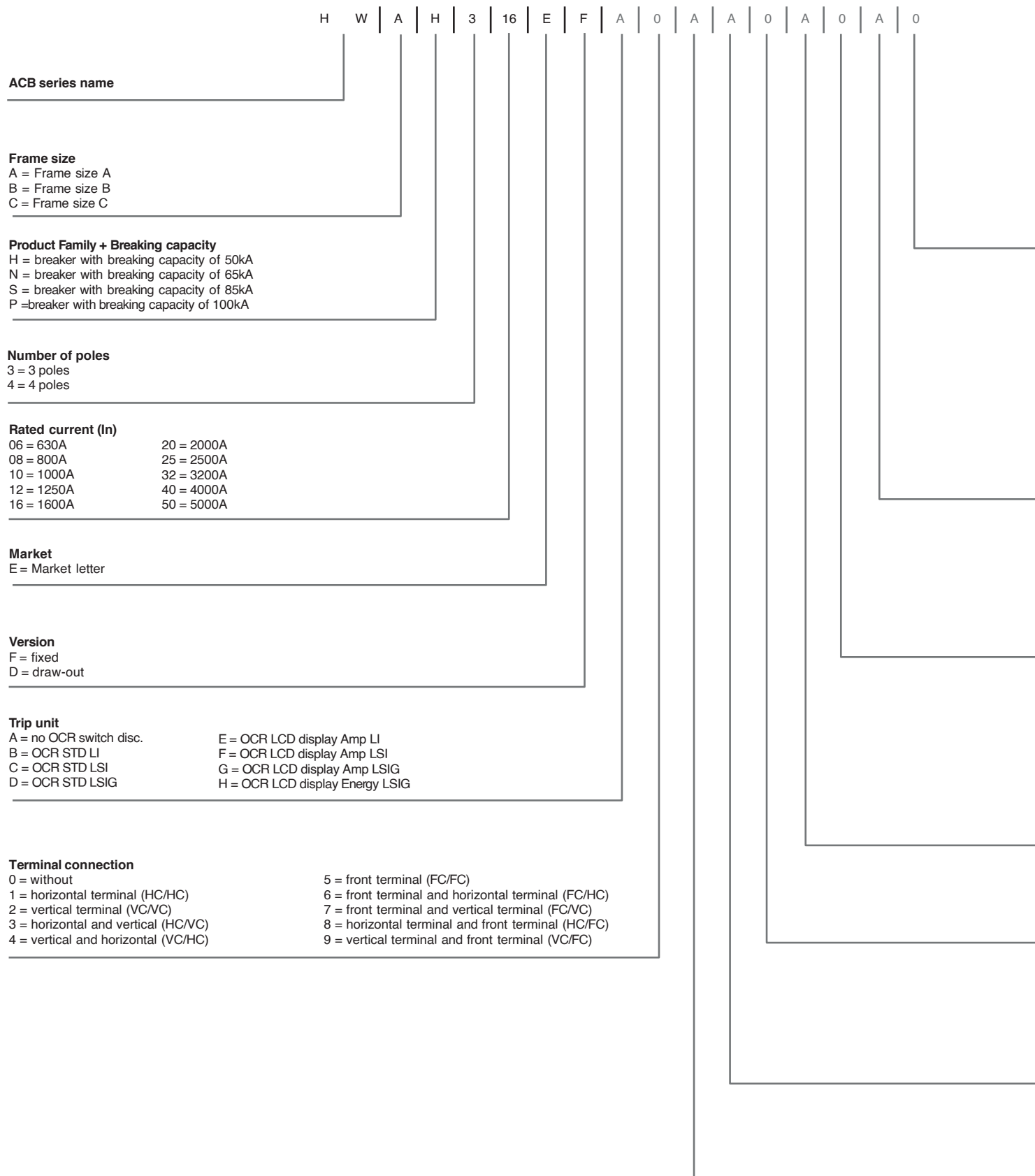

Air Circuit Breakers

Position switch (only DO ACB) & mechanical interlock (pre-assembled)

- 0 = without
- 1 = isolated 1C, test 1C, connected 2C
- 2 = inserted 1C, isolated 1C, test 1C, connected 1C
- 3 = inserted 1C, isolated 1C, test 3C, connected 3C
- 4 = inserted 2C, isolated 2C, test 2C, connected 2C
- 5 = without & MI
- 6 = isolated 1C, test 1C, connected 2C & MI
- 7 = inserted 1C, isolated 1C, test 1C, connected 1C & MI
- 8 = inserted 1C, isolated 1C, test 3C, connected 3C & MI
- 9 = inserted 2C, isolated 2C, test 2C, connected 2C & MI

OFF lock (key lock device)

- A = without
- B = type 1 (key lock device)
- C = type 2 (key lock device)
- D = type 3 (key lock device)
- E = type 4 (key lock device)
- F = type 5 (key lock device)
- G = Ronis type 1 - K1-L1/L4
- H = Ronis type 2 - K2-L2/4/5
- I = Ronis type 3 - K3-L3/5
- J = Ronis type 4 - K4-L4
- K = Ronis type 5 - K5-L5
- L = Castell type 1 - AA
- M = Castell type 2 - AB
- N = Castell type 3 - A_

MOC 2nd Auxiliary Switch & Counter & Arc Shield (only DO ACB)

- 0 = without Counter & without MOC & without Arc Shield
- 1 = with Counter & without MOC & without Arc Shield
- 2 = without Counter & with MOC & without Arc Shield
- 3 = with Counter & with MOC & without Arc Shield
- 4 = without Counter & without MOC & with Arc Shield
- 5 = with Counter without MOC & with Arc Shield
- 6 = without Counter & with MOC & with Arc Shield
- 7 = with Counter & with MOC & with Arc Shield

Under voltage release or 2nd SH coil

- | | |
|--------------------------------|-------------------------------------|
| A = without | K = AC 440V with time delay |
| B = AC/DC 110V | L = DC 24V with time delay |
| C = AC/DC 220V | M = DC 48V with time delay |
| D = AC 380V | N = AC/DC 110V double shunt release |
| E = AC 440V | O = AC/DC 220V double shunt release |
| F = DC 24V | P = AC 380V double shunt release |
| G = DC 48V | Q = AC 440V double shunt release |
| H = AC/DC 110V with time delay | R = DC 24V double shunt release |
| I = AC/DC 220V with time delay | S = DC 48V double shunt release |
| J = AC 380V with time delay | |

Closing release

- | | |
|----------------|-------------|
| 0 = without | 4 = AC 440V |
| 1 = AC/DC 110V | 5 = DC 24V |
| 2 = AC/DC 220V | 6 = DC 48V |
| 3 = AC 380V | |

Motor operator & ready to close switch

- | | |
|---------------------------|-------------------------------|
| A = without | N = AC/DC 110V motor with RTC |
| B = AC/DC 110V motor only | O = AC/DC 220V motor with RTC |
| C = AC/DC 220V motor only | P = AC 380V motor with RTC |
| D = AC 380V motor only | Q = AC 440V motor with RTC |
| E = AC 440V motor only | R = DC 24V motor with RTC |
| F = DC 24V motor only | S = DC 48V motor with RTC |
| G = DC 48V motor only | U = without motor with RTC |

Shunt release

- | | |
|----------------|-------------|
| A = without | E = AC 440V |
| B = AC/DC 110V | F = DC 24V |
| C = AC/DC 220V | G = DC 48V |
| D = AC380V | |

01 Intelligent OCR

LSIGN protection, LCD display, pretrip alarm, fault recording, remote reset, Signal indication LED PTA/LSI/GF/COM.



02 Flexible protection

Can switch ON/OFF LSIGN and thermal memory separately.



03 Easy communication

To build up communication network, Communication module integrated in OCR.



04 Easy maintenance

Event record 200, fault record 250 (reserved for ever), OCR checker tool.



05 Flexible terminal connection

Horizontal/Vertical terminal rotate at 90° to make it easier for panel builder to mount on busbars. For frame A up to 1600A and frame B up to 3200A.



06 Wide range of accessories

Including: arc shield, phase barrier, temperature sensor, dust cover (IP54)





HHS025DR

h3+ MCCBs thermal magnetic release

Characteristics:

- Complies with IEC 60947-2
- 3 Frame sizes: P160 , P250 & P630
- Thermal Magnetic Trip Unit with adjustable O/L and S/C
- Adjustable Overload from 63% to 100%
- Neutral Protection for all 4P breakers as standard (option of OFF / 50% / 100% Neutral setting)
- Calibrated at 50°C
- Current Limiting type
- Complete range of accessories
- Direct mounting arrangement for Extended Rotary Handle for quick installation
- International Certification and approvals

Breaking Capacity

Ics=100% Icu as per IEC 60947-2	Rated Current	Frame	Cat. Ref. 3 Pole	Unit MRP (₹)	Cat. Ref. 4 Pole	Unit MRP (₹)
25kA	40A	P160	HHS040DR	10830	HHS041DR	12730
	63A		HHS063DR	10830	HHS064DR	12910
	80A		HHS080DR	10830	HHS081DR	12730
	100A		HHS100DR	10680	HHS101DR	12790
	125A		HHS125DR	17120	HHS126DR	20880
	160A	HHS160DR	18900	HHS161DR	23430	
	200A	P250	HHT200DR	30940	HHT201DR	37220
	250A		HHT250DR	31080	HHT251DR	38310
	320A		HHJ320DR	39340	HHJ321DR	49290
	400A	P630	HHJ400DR	39190	HHJ401DR	49970
	630A		HHJ630DE	50780	HHJ631DE	59950

Breaking Capacity

Ics=100% Icu as per IEC 60947-2	Rated Current	Frame	Cat. Ref. 3 Pole	Unit MRP (₹)	Cat. Ref. 4 Pole	Unit MRP (₹)
40kA	40A	P160	HNS040DR	12330	HNS041DR	14480
	63A		HNS063DR	12330	HNS064DR	14480
	80A		HNS080DR	12330	HNS081DR	14480
	100A		HNS100DR	12330	HNS101DR	14690
	125A		HNS125DR	18040	HNS126DR	22100
	160A	HNS160DR	19960	HNS161DR	24820	
	200A	P250	HNT200DR	31340	HNT201DR	41470
	250A		HNT250DR	33310	HNT251DR	41890
	320A		HNJ320DR	39570	HNJ321DR	50060
	400A	P630	HNJ400DR	39980	HNJ401DR	50750
	630A		HNJ630DE	50360	HNJ631DE	60300

Breaking Capacity

Ics=100% Icu as per IEC 60947-2	Rated Current	Frame	Cat. Ref. 3 Pole	Unit MRP (₹)	Cat. Ref. 4 Pole	Unit MRP (₹)
50kA	40A	P160	HMS040DR	16110	HMS041DR	20230
	63A		HMS063DR	16110	HMS064DR	20230
	80A		HMS080DR	16110	HMS081DR	20230
	100A		HMS100DR	16110	HMS101DR	20230
	125A		HMS125DR	20280	HMS126DR	23960
	160A	HMS160DR	23420	HMS161DR	27520	
	200A	P250	HMT200DR	35230	HMT201DR	43040
	250A		HMT250DR	36240	HMT251DR	46080
	320A		HMJ320DR	44930	HMJ321DR	54740
	400A	P630	HMJ400DR	44610	HMJ401DR	55750
	630A		HMJ630DE	57840	HMJ631DE	73550

h3+ Thermal Magnetic Releases

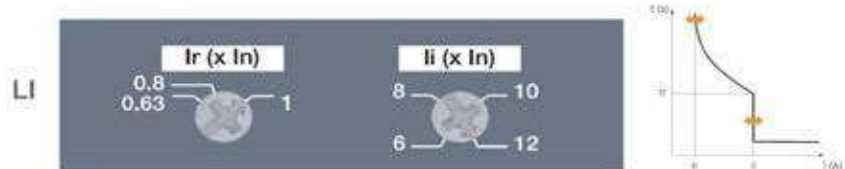

+ Rated Current (Ir) Settings from 63% In

+ Neutral Protection in 4P versions (with option to switch off)

L – Long Time / I – Instantaneous



HHT250JR

h3+ MCCBs microprocessor LSI release

Characteristics:

- Complies with IEC 60947-2
- 3 Frame sizes: P160, P250 & P630
- Microprocessor Trip Unit with LSI Protection
- Adjustable Overload with Delay / Short Circuit with adjustable Delay / Instantaneous
- I2T ON / OFF for precise coordination
- Dedicated Pre Trip Alarm Contact to help in service continuity

- Accurate setting of overload protection
- Neutral Protection for all 4P breakers as standard (option of OFF / 50% / 100% Neutral setting)
- Complete range of accessories
- Direct mounting arrangement for Extended Rotary Handle for quick installation
- International Certification and approvals

Breaking Capacity
Ics=100% Icu as per IEC 60947-2)

Rated Current	Frame	Cat. Ref. 3 Pole	Unit MRP (₹)	Cat. Ref. 4 Pole	Unit MRP (₹)
40A	P160	HHS040JR	21790	HHS041JR	28300
		HHS100JR	21790	HHS101JR	28030
100A	P250	HHS160JR	27830	HHS161JR	36020
		HHT250JR	36580	HHT251JR	46920

Breaking Capacity
Ics=100% Icu as per IEC 60947-2)

Rated Current	Frame	Cat. Ref. 3 Pole	Unit MRP (₹)	Cat. Ref. 4 Pole	Unit MRP (₹)
40A	P160	HNS040JR	21840	HNS041JR	27780
		HNS100JR	21840	HNS101JR	27780
100A	P250	HNS160JR	27920	HNS161JR	39230
		HNT250JR	38500	HNT251JR	52590
400A	P630	HNW400JR	61150	HNW401JR	69810
		HNW630JR	64640	HNW631JR	83800

Breaking Capacity
Ics=100% Icu as per IEC 60947-2)

Rated Current	Frame	Cat. Ref. 3 Pole	Unit MRP (₹)	Cat. Ref. 4 Pole	Unit MRP (₹)
40A	P160	HMS040JR	25120	HMS041JR	34410
		HMS100JR	25120	HMS101JR	35440
100A	P250	HMS160JR	31850	HMS161JR	41240
		HMT250JR	43160	HMT251JR	59100
400A	P630	HMW400JR	64000	HMW401JR	83030
		HMW630JR	66260	HMW631JR	87790

h3+ Range Overview Electronic Releases

LSI
LSIG

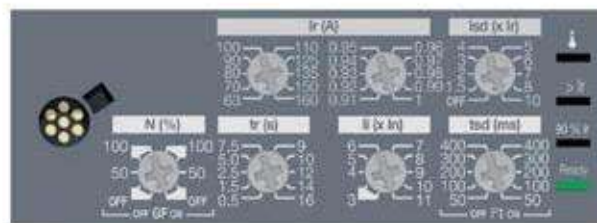

Trip unit LSI/LSIG

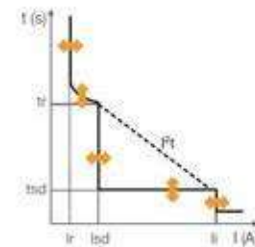

- + Easy Dial Settings in Absolute Value for Ir
- + Rated Current Settings with Fine Tuning From 35% of In
- + I2t On / Off Feature for precise coordination

L – Long Time / S – Short Time / I – Instantaneous / G – Ground Fault
LSI – S with adjustable delay



HHT250LR

h3+ MCCBs microprocessor LSIG release

Characteristics:

- Complies with IEC 60947-2
- 3 Frame sizes: P160, P250 & P630
- Microprocessor Trip Unit with LSIG Protection
- Adjustable Overload with Delay / Short Circuit with adjustable Delay / Ground Fault / Instantaneous
- I2T ON / OFF for precise coordination
- Dedicated PreTrip Alarm Contact to help in service continuity
- Accurate setting of overload protection
- Neutral Protection for all 4P breakers as standard (option of OFF / 50% / 100% Neutral setting)
- Complete range of accessories
- Direct mounting arrangement for Extended Rotary Handle for quick installation
- International Certification and approvals

Breaking Capacity

Ics=100% Icu as per IEC 60947-2	Rated Current	Frame	Cat. Ref. 3 Pole	Unit MRP (₹)	Cat. Ref. 4 Pole	Unit MRP (₹)
25kA	40A	P250	HHT040LR	39250	HHT041LR	43930
	100A		HHT100LR	39250	HHT101LR	43930
	160A		HHT160LR	41510	HHT161LR	49910
	250A	HHT250LR	47530	HHT251LR	56950	

Breaking Capacity

Ics=100% Icu as per IEC 60947-2	Rated Current	Frame	Cat. Ref. 3 Pole	Unit MRP (₹)	Cat. Ref. 4 Pole	Unit MRP (₹)
40kA	40A	P250	HNT040LR	39440	HNT041LR	45660
	100A		HNT100LR	39440	HNT101LR	45660
	160A		HNT160LR	42900	HNT161LR	51510
	250A	P630	HNT250LR	48100	HNT251LR	59670
	400A		HNW400LR	68340	HNW401LR	77760
	630A		HNW630LR	78530	HNW631LR	92440

Breaking Capacity

Ics=100% Icu as per IEC 60947-2	Rated Current	Frame	Cat. Ref. 3 Pole	Unit MRP (₹)	Cat. Ref. 4 Pole	Unit MRP (₹)
50kA	40A	P250	HMT040LR	42900	HMT041LR	49160
	100A		HMT100LR	42900	HMT101LR	49160
	160A		HMT160LR	48700	HMT161LR	52660
	250A	P630	HMT250LR	52040	HMT251LR	61090
	400A		HMW400LR	70240	HMW401LR	83880
	630A		HMW630LR	78810	HMW631LR	98350

h3+ Key Benefits



Integrated PTA output contact
Output contact dedicated to the overload prealarm.

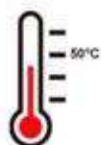

No derating up to 50°C



High contrast display
Display on h3+ Energy breakers can be oriented in any direction to match the MCCB orientation.



Integrated OAC output contact
Output contact assignable to a custom alarm with access behind the front cover. Available in Energy release



HHS040NR

h3+ MCCBs microprocessor LSIG - energy release

Characteristics:

- Complies with IEC 60947-2
- 3 Frame sizes: P160, P250 & P630
- Microprocessor Trip Unit with LSIG Protection, OLED Display
- Multifunction Metering with accuracy class 0.5 for V & I
- Adjustable Overload with Delay / Short Circuit with adjustable Delay / Ground Fault / Instantaneous
- I2T ON / OFF for precise coordination
- Pre Trip Alarm Contact to help in service continuity
- Alarm Management with dedicated alarm contact
- ZSI for intelligent discrimination
- Optimal Panel mounted display for visualization and control
- Complete range of accessories
- Direct mounting arrangement for Extended Rotary Handle for quick installation
- International Certification and approvals

Breaking Capacity

Ics=100% Icu as per IEC 60947-2)	Rated Current	Frame	Cat. Ref. 3 Pole	Unit MRP (₹)	Cat. Ref. 4 Pole	Unit MRP (₹)
25kA	40A	P160	HHS040NR	#	HHS041NR	#
	100A		HHS100NR	#	HHS101NR	#
	160A		HHS160NR	#	HHS161NR	#
	250A	P250	HHT250NR	#	HHT251NR	#

Breaking Capacity

Ics=100% Icu as per IEC 60947-2)	Rated Current	Frame	Cat. Ref. 3 Pole	Unit MRP (₹)	Cat. Ref. 4 Pole	Unit MRP (₹)	
40kA	40A	P160	HNS040NR	#	HNS041NR	#	
	100A		HNS100NR	#	HNS101NR	#	
	160A		HNS160NR	#	HNS161NR	#	
	250A	P250	HNT250NR	#	HNT251NR	#	
	400A		P630	HNW400NR	#	HNW401NR	#
	330A			HNW630NR	#	HNW631NR	#

Breaking Capacity

Ics=100% Icu as per IEC 60947-2)	Rated Current	Frame	Cat. Ref. 3 Pole	Unit MRP (₹)	Cat. Ref. 4 Pole	Unit MRP (₹)	
50kA	40A	P160	HMS040NR	#	HMS041NR	#	
	100A		HMS100NR	#	HMS101NR	#	
	160A		HMS160NR	#	HMS161NR	#	
	250A	P250	HMT250NR	#	HMT251NR	#	
	400A		P630	HMW400NR	#	HMW401NR	#
	630A			HMW630NR	#	HMW631NR	#

Price on Request

h3+ Energy Release with embedded display



Energy electronic trip unit with:

- + Embedded OLED display (Detachable)
- + Easy usability through single Joystick
- + Measurement features (I, V, P, E, PF, THD, F...)
- + Class 0.5 accuracy for V & I according to IEC 61557-12
- + Alarm management and event histories
- + Inbuilt Output contacts for alarms
- + Modbus communication for remote monitoring and control
- + Configuration via wifi for easy maintenance
- + Panel display for Local Visualization & control
- + ZSI for Intelligent Discrimination

h3+ traditional version

Guaranteed protection

The new range of moulded case circuit breakers provides solutions suitable for electrical installations in commercial buildings. It offers reliable protection against overloads and short circuits.

The multiple setting options, created by coordinating the protection systems, offer the best possible combinations. This brings a threefold benefit: guaranteeing user and equipment safety under all conditions, ensuring continuity of service and availability of energy in normal operating situations, and, in case of transient faults, reducing the risks to the installation's components.



All products in the new range can be easily integrated in the hager enclosure systems.



- Most compact product on the market with measurement and communication.
- From 25 to 630 A
- Three frame sizes
- Can be mounted on the DIN rail in option up to 250 A
- TM, MAG, LSnl, LSI, LSIg and Energy trip units
- Breaking capacity of 25, 40, 50, 70 and 110 kA at 415 VAC
- 3P3D or 4P4D (neutral adjustable to 0, 50 or 100 %)
- Wide range of auxiliaries and accessories
- Horizontal or vertical installation

01

Secure screw

The **quarter-turn** auxiliary access system saves time when installing the product. The secure screw offers additional comfort.



02

Hinged front cover

The front cover offers multiple advantages. It is mounted on hinges. It remains integral with the case once opened, preventing incorrect refitting.



03

Auxiliary window

The type of auxiliaries can be seen directly through the windows on the front panel, without removing the cover.

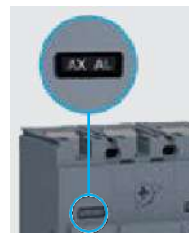

04

Integrated padlock

The handle can be directly locked with no need for extra accessories.



All the technical specifications are available in the technical repository and the network calculation software, hagercad.net.



HXA011H

Description	Pack Qty.	Cat. Ref.	Unit MRP (₹)
P160 Frame			
Auxiliary Contact	1	HXA021H	1620
Alarm Contact	1	HXA024H	1620
Shunt 230V AC	1	HXA004H	3350
UnderVoltage - 24V DC	1	HXA011H	4160
UnderVoltage - 240V DC	1	HXA014H	4160
UnderVoltage - 415V AC	1	HXA015H	4100
Direct Rotary Handle	1	HXS030H	1640
Extended Rotary Handle	1	HXS031H	2620
Spreaders - 3P	1	HYS011H	890
Spreaders - 4P	1	HYS012H	1160
Interphase barrier 3/4P	1	HYS019H	550



HXA004H

Description	Pack Qty.	Cat. Ref.	Unit MRP (₹)
P250 Frame			
Auxiliary Contact	1	HXA021H	1620
Alarm Contact	1	HXA024H	1620
Shunt 230V AC	1	HXA004H	3350
UnderVoltage - 24V DC	1	HXA011H	4160
UnderVoltage - 240V DC	1	HXA014H	4160
UnderVoltage - 415V AC	1	HXA015H	4100
Direct Rotary Handle	1	HXT030H	1790
Extended Rotary Handle	1	HXT031H	2850
Spreaders - 3P	1	HYB011H	890
Spreaders - 4P	1	HYB012H	1220
Interphase barrier 3/4P	1	HYT019H	560
Motor Mechanism (auto reset) 240V AC	1	HXT042H	32920



HXW030H

Description	Pack Qty.	Cat. Ref.	Unit MRP (₹)
P630 Frame			
Auxiliary Contact	1	HXA021H	1620
Alarm Contact	1	HXA024H	1620
Shunt 230V AC	1	HXA004H	3350
UnderVoltage - 24V DC	1	HXA011H	4160
UnderVoltage - 240V DC	1	HXA014H	4160
UnderVoltage - 415V AC	1	HXA015H	4100
Direct Rotary Handle	1	HXW030H	2740
Extended Rotary Handle	1	HXW031H	5170
Spreaders - 3P	1	HYD014H	2320
Spreaders - 4P	1	HYD015H	2750
Interphase barrier 3/4P	1	HYW019H	1190
Motor Mechanism (auto reset) 240V AC	1	HXW042H	52460

HDA125Z
MCCBs thermal magnetic release
Characteristics:

- Complies with IEC 60947-2
- Thermal Magnetic and Microprocessor Trip Units
- Calibrated at 50°C
- Current Limiting type
- Complete range of accessories
- International Certification and approvals
- BIS certified

X160 frame MCCB
fixed overload, fixed short circuit
 breaking capacity
 Icu : 18kA

Description	Pack Qty.	Cat. Ref.	Unit MRP (₹)
32A, 3 pole	1	HDA032Z	7250
40A, 3 pole	1	HDA040Z	7250
63A, 3 pole	1	HDA063Z	7250
80A, 3 pole	1	HDA080Z	7250
100A, 3 pole	1	HDA100Z	7250
125A, 3 pole	1	HDA125Z	8850
160A, 3 pole	1	HDA160Z	9740

HHA125Z
X160 frame MCCB
fixed overload, fixed short circuit
 breaking capacity
 Icu : 25kA

Description	Pack Qty.	Cat. Ref.	Unit MRP (₹)
32A, 3 pole	1	HHA032Z	9000
40A, 3 pole	1	HHA040Z	9000
63A, 3 pole	1	HHA063Z	8870
80A, 3 pole	1	HHA080Z	8870
100A, 3 pole	1	HHA100Z	8870
125A, 3 pole	1	HHA125Z	11960
160A, 3 pole	1	HHA160Z	14920

32A, 4 pole	1	HHA033Z	12270
40A, 4 pole	1	HHA041Z	12270
63A, 4 pole	1	HHA064Z	12210
80A, 4 pole	1	HHA081Z	12270
100A, 4 pole	1	HHA101Z	12270
125A, 4 pole	1	HHA126Z	15460
160A, 4 pole	1	HHA161Z	18760



HDA161U

X160 frame MCCB
overload adjustable 0.63-0.8-1 x In
short circuit fixed
breaking capacity
Icu : 18kA

Description	Pack Qty.	Cat. Ref.	Unit MRP (₹)
40A, 3 pole	1	HDA040U	8170
63A, 3 pole	1	HDA063U	8170
80A, 3 pole	1	HDA080U	8170
100A, 3 pole	1	HDA100U	8170
125A, 3 pole	1	HDA125U	9720
160A, 3 pole	1	HDA160U	11250

40A, 4 pole	1	HDA041U	10690
63A, 4 pole	1	HDA064U	10540
80A, 4 pole	1	HDA081U	10540
100A, 4 pole	1	HDA101U	10540
125A, 4 pole	1	HDA126U	11170
160A, 4 pole	1	HDA161U	12430



HHA161U

X160 frame MCCB
overload adjustable 0.63-0.8-1 x In
short circuit fixed
breaking capacity
Icu : 25kA

Description	Pack Qty.	Cat. Ref.	Unit MRP (₹)
40A, 3 pole	1	HHA040U	10260
63A, 3 pole	1	HHA063U	10260
80A, 3 pole	1	HHA080U	10260
100A, 3 pole	1	HHA100U	10110
125A, 3 pole	1	HHA125U	12330
160A, 3 pole	1	HHA160U	15170

40A, 4 pole	1	HHA041U	13870
63A, 4 pole	1	HHA064U	13670
80A, 4 pole	1	HHA081U	13870
100A, 4 pole	1	HHA101U	13670
125A, 4 pole	1	HHA126U	16080
160A, 4 pole	1	HHA161U	19670



HNA126U

X160 frame MCCB
overload adjustable 0.63-0.8-1 x In
short circuit fixed
breaking capacity
Icu : 40kA

Description	Pack Qty.	Cat. Ref.	Unit MRP (₹)
40A, 3 pole	1	HNA040U	12690
63A, 3 pole	1	HNA063U	12690
80A, 3 pole	1	HNA080U	12690
100A, 3 pole	1	HNA100U	12690
125A, 3 pole	1	HNA125U	15220
160A, 3 pole	1	HNA160U	19030

40A, 4 pole	1	HNA041U	16860
63A, 4 pole	1	HNA064U	16860
80A, 4 pole	1	HNA081U	16860
100A, 4 pole	1	HNA101U	16860
125A, 4 pole	1	HNA126U	18030
160A, 4 pole	1	HNA161U	21460



HNB100U

X250 frame MCCB
fixed overload, fixed short circuit
Icu : 25kA

Description	Pack Qty.	Cat. Ref.	Unit MRP (₹)
200A, 3 pole	1	▶ HHB200Z	18490
250A, 3 pole	1	▶ HHB250Z	23650
200A, 4 pole	1	▶ HHB201Z	19780
250A, 4 pole	1	▶ HHB251Z	25350

Over load adjustable 0.63-0.8-1 x In
short circuit adjustable
6-8-10-13 x In (100-200A)
5-7-9-11 x In (250A)
Icu : 40kA

Description	Pack Qty.	Cat. Ref.	Unit MRP (₹)
100A, 3 pole	1	HNB100U	14150
125A, 3 pole	1	HNB125U	15770
160A, 3 pole	1	HNB160U	20860
200A, 3 pole	1	▶ HNB200U	21820
250A, 3 pole	1	▶ HNB250U	29830
100A, 4 pole	1	HNB101U	18130
125A, 4 pole	1	HNB126U	19040
160A, 4 pole	1	HNB161U	24010
200A, 4 pole	1	▶ HNB201U	31630
250A, 4 pole	1	▶ HNB251U	35900

H1000 frame MCCB
Over load adjustable 0.4-1.0 x In
short circuit adjustable
2.5-10 x Ir (630-800A)
2.5-8 x In (1000A)
time delay 0.1-0.2 sec
Icu : 50kA

Description	Pack Qty.	Cat. Ref.	Unit MRP (₹)
800A, 3 pole	1	▶ HNE800H	129350
1000A, 3 pole	1	HNE970H	152790
800A, 4 pole	1	▶ HNE801H	161370
1000A, 4 pole	1	HNE971H	204030



HXA021H

Description	Pack Qty.	Cat. Ref.	Unit MRP (₹)
X160 Frame MCCB			
Auxiliary Contact	1	HXA021H	1620
Alarm Contact	1	HXA024H	1620
Shunt 230V AC	1	HXA004H	3350
UnderVoltage - 24V DC	1	HXA011H	4160
UnderVoltage - 240V AC	1	HXA014H	4160
UnderVoltage - 415V AC	1	HXA015H	4100
Direct Rotary Handle	1	HXA030H	2060
Extended Rotary Handle	1	HXA031H	2830
Spreaders - 3P	1	HYA014H	780
Speaders - 4P	1	HYA015H	1050
Phase barriers - 3P / 4P	1	HYB019H	295
DIN Rail Adaptor	1	HYA033H	580



HXA030H

Description	Pack Qty.	Cat. Ref.	Unit MRP (₹)
X250 Frame MCCB			
Auxiliary Contact	1	HXA021H	1620
Alarm Contact	1	HXA024H	1620
Shunt 230V AC	1	HXA004H	3350
UnderVoltage - 24V DC	1	HXA011H	4160
UnderVoltage - 240V AC	1	HXA014H	4160
UnderVoltage - 415V AC	1	HXA015H	4100
Direct Rotary Handle	1	HXB030H	2170
Extended Rotary Handle	1	HXB031H	3210
Motor Operator 240VAC	1	HXB042H	33290
Spreaders - 3P	1	HYB011H	890
Speaders - 4P	1	HYB012H	1220
Phase barriers - 3P / 4P	1	HYB019H	295
Mechanical Interlock	1	HXB065H	20435



HXC021H

Description	Pack Qty.	Cat. Ref.	Unit MRP (₹)
H1000 Frame MCCB			
Auxiliary Contact	1	HXC021H	1750
Alarm Contact	1	HXC024H	1750
Shunt 230V AC	1	HXC004H	4070
UnderVoltage - 240V AC	1	HXE014H	3580
UnderVoltage - 415V AC	1	HXE015H	3580
Direct Rotary Handle	1	HXE030H	4635
Extended Rotary Handle	1	HXE031H	8360
Motor Operator 240VAC	1	HXE042H	54000
Mechanical Interlock	1	HXE065H	127440



Power Contactor

Characteristics:

- 9A to 630 A Rated Current - 690V insulation voltage - Wide operating coil - 3 pole

Model	AC3 Rating (A)	Coil voltage	Aux	Pack Qty.	Cat. Ref.	Unit MRP (₹)
HWC-09	9A	110V 50/60Hz	1NO+1NC	1	EX000911C	1130
	9A	230V 50/60Hz	1NO+1NC	1	EX000911D	1130
	9A	415V 50/60Hz	1NO+1NC	1	EX000911E	1130
HWC-12	12A	110V 50/60Hz	1NO+1NC	1	EX001211C	1260
	12A	230V 50/60Hz	1NO+1NC	1	EX001211D	1260
	12A	415V 50/60Hz	1NO+1NC	1	EX001211E	1260
HWC-16	16A	110V 50/60Hz	1NO+1NC	1	EX001611C	1450
	16A	230V 50/60Hz	1NO+1NC	1	EX001611D	1450
	16A	415V 50/60Hz	1NO+1NC	1	EX001611E	1450
HWC-18	18A	110V 50/60Hz	1NO+1NC	1	EX001811C	1450
	18A	230V 50/60Hz	1NO+1NC	1	EX001811D	1450
	18A	415V 50/60Hz	1NO+1NC	1	EX001811E	1450
HWC-22	22A	110V 50/60Hz	1NO+1NC	1	EX002211C	2050
	22A	230V 50/60Hz	1NO+1NC	1	EX002211D	2050
	22A	415V 50/60Hz	1NO+1NC	1	EX002211E	2050
HWC-25	25A	110V 50/60Hz	1NO+1NC	1	EX002511C	2050
	25A	230V 50/60Hz	1NO+1NC	1	EX002511D	2050
	25A	415V 50/60Hz	1NO+1NC	1	EX002511E	2050
HWC-32	32A	110V 50/60Hz	1NO+1NC	1	EX003211C	3960
	32A	230V 50/60Hz	1NO+1NC	1	EX003211D	3960
	32A	415V 50/60Hz	1NO+1NC	1	EX003211E	3960
HWC-40	40A	110V 50/60Hz	1NO+1NC	1	EX004011C	6230
	40A	230V 50/60Hz	1NO+1NC	1	EX004011D	6230
	40A	415V 50/60Hz	1NO+1NC	1	EX004011E	6230
HWC-50	50A	110V 50/60Hz	1NO+1NC	1	EX005011C	7700
	50A	230V 50/60Hz	1NO+1NC	1	EX005011D	7700
	50A	415V 50/60Hz	1NO+1NC	1	EX005011E	7700
HWC-65	65A	110V 50/60Hz	1NO+1NC	1	EX006511C	10540
	65A	230V 50/60Hz	1NO+1NC	1	EX006511D	10540
	65A	415V 50/60Hz	1NO+1NC	1	EX006511E	10540
HWC-75	75A	110V 50/60Hz	1NO+1NC	1	EX007511C	13540
	75A	230V 50/60Hz	1NO+1NC	1	EX007511D	13540
	75A	415V 50/60Hz	1NO+1NC	1	EX007511E	13540
HWC-85	85A	110V 50/60Hz	1NO+1NC	1	EX008511C	13540
	85A	230V 50/60Hz	1NO+1NC	1	EX008511D	13540
	85A	415V 50/60Hz	1NO+1NC	1	EX008511E	13540
HWC-100	100A	110V 50/60Hz	1NO+1NC	1	EX010011C	17060
	100A	230V 50/60Hz	1NO+1NC	1	EX010011D	17060
	100A	415V 50/60Hz	1NO+1NC	1	EX010011E	17060
HWC-160	160A	110V 50/60Hz	2NO+2NC	1	EX016022C	27100
	160A	230V 50/60Hz	2NO+2NC	1	EX016022D	27100
	160A	415V 50/60Hz	2NO+2NC	1	EX016022E	27100
HWC-185	185A	110V 50/60Hz	2NO+2NC	1	EX018522C	28910
	185A	230V 50/60Hz	2NO+2NC	1	EX018522D	28910
	185A	415V 50/60Hz	2NO+2NC	1	EX018522E	28910
HWC-225	225A	110V 50/60Hz	2NO+2NC	1	EX022522C	31390
	225A	230V 50/60Hz	2NO+2NC	1	EX022522D	31390
	225A	415V 50/60Hz	2NO+2NC	1	EX022522E	31390
HWC-265	265A	110V AC/DC	2NO+2NC	1	EX026522C	40260
	265A	230V AC/DC	2NO+2NC	1	EX026522G	40260
	265A	415V AC/DC	2NO+2NC	1	EX026522H	40260
HWC-330	330A	110V AC/DC	2NO+2NC	1	EX033022F	52510
	330A	230V AC/DC	2NO+2NC	1	EX033022G	52510
	330A	415V AC/DC	2NO+2NC	1	EX033022H	52510
HWC-400	400A	110V AC/DC	2NO+2NC	1	EX040022F	66760
	400A	230V AC/DC	2NO+2NC	1	EX040022G	66760
	400A	415V AC/DC	2NO+2NC	1	EX040022H	66760
HWC-630	630A	110V AC/DC	2NO+2NC	1	EX063022F	93150
	630A	230V AC/DC	2NO+2NC	1	EX063022G	93150
	630A	415V AC/DC	2NO+2NC	1	EX063022H	93150



OLR (OverLoad Relay)

Characteristics:

- Phase loss protection
- Auto and Manual reset

- Three Phase bimetal for overload protection
- Applicable for 3P HWC Contactor Range

Model	Overload Protection Range	Pack Qty.	Cat. Ref.	Unit MRP (₹)
HWR-25	1.6-2.5A	1	EXB00025B	1860
	2.5-4A	1	EXB00004B	1860
	4-6A	1	EXB00006B	1860
	5.5-8A	1	EXB00008B	1860
	7-10A	1	EXB00010B	1860
	9-13A	1	EXB00013B	1860
	12-18A	1	EXB00018B	1860
	17-25A	1	EXB000025B	1860
HWR-38	23A-32A	1	EXB00032C	3240
	30A-38A	1	EXB00038C	3240
	23A-32A	1	EXB000032C	5700
	30A-40A	1	EXB00040C	5700
HWR-100	37A-50A	1	EXB00050C	5700
	48A-65A	1	EXB00065C	5700
	55A-70A	1	EXB00070C	5700
	63A-80A	1	EXB00080C	5700
HWR-200	80A-100A	1	EXB00100C	5700
	100A-200A	1	EXB00200E	19380
	125A-250A	1	EXB00250F	23210
HWR-630	200A-400A	1	EXB00400F	23210
	315A-630A	1	EXB00630F	23210

Accessories for Power Contactor

Description	Pack Qty.	Cat. Ref.	Unit MRP (₹)
Aux Contact 2NO Top Mounted	10	EXA000	440
Aux Contact 1NO+1NC Top Mounted	10	EXA001	440
Aux Contact 2NC Top Mounted	10	EXA002	440
Aux Contact 4NO Top Mounted	10	EXA003	830
Aux Contact 3NO+1NC Top Mounted	10	EXA004	830
Aux Contact 2NO+2NC Top Mounted	10	EXA005	830
Aux Contact 1NO+3NC Top Mounted	10	EXA006	830
Aux Contact 1NC Top Mounted	10	EXA007	830
Aux Contact 1NO+1NC Side Mounted HWC-06~225	10	EXA111	860
Aux Contact 1NO+1NC Side Mounted HWC-265~630	10	EXA112	860
HWC-09-22 coil 110V 50/60Hz	5	EXA201	820
HWC-09-22 coil 230V 50/60Hz	5	EXA202	820
HWC-09-22 coil 415V 50/60Hz	5	EXA203	820
HWC-25-32 coil 110V 50/60Hz	7	EXA211	850
HWC-25-32 coil 230V 50/60Hz	7	EXA212	850
HWC-25-32 coil 415V 50/60Hz	7	EXA213	850
HWC-40-65 coil 110V 50/60Hz	2	EXA221	1200
HWC-40-65 coil 230V 50/60Hz	2	EXA222	1200
HWC-40-65 coil 415V 50/60Hz	2	EXA223	1200
HWC-75-100 coil 110V 50/60Hz	2	EXA231	1530
HWC-75-100 coil 230V 50/60Hz	2	EXA232	1530
HWC-75-100 coil 415V 50/60Hz	2	EXA233	1530



MPCB (Motor Protection Circuit Breaker)

Characteristics:

- 10A Trip Class (10 for Fr-80)
- Class III pollution degree
- Available in 3P version

Frame	Rated Current (A)	Overload Protection Range	Breaking Capacity Icu	Pack Qty.	Cat. Ref.	Unit MRP (₹)
Fr-25	0.16	0.1-0.16A	100	1	MMB50100	3270
	0.25	0.16-0.25A	100	1	MMB50200	3270
	0.4	0.25-0.4A	100	1	MMB50300	3270
	0.63	0.4-0.63A	100	1	MMB50400	3270
	1	0.63-1A	100	1	MMB50500	3270
	1.6	1-1.6A	100	1	MMB50600	3270
	2.5	1.6-2.5A	100	1	MMB50700	3270
	4	2.5-4A	100	1	MMB50800	3270
	6.3	4-6.3A	100	1	MMB50900	3270
	10	6-10A	100	1	MMB51000	3270
Fr-80	14	9-14A	100	1	MMB51100	3270
	18	13-18A	100	1	MMB51200	3270
	23	17-23A	100	1	MMB51300	3270
	25	20-25A	100	1	MMB51400	3270
	32	23-32A	50	1	MMB51600	14340
	40	30-40A	50	1	MMB51500	14340
	65	48-65A	50	1	MMB51700	14340
	80	63-80A	50	1	MMB51800	14340

Accessories for MPCB

Description	Pack Qty.	Cat. Ref.	Unit MRP (₹)
Fr-25 Alarm contact side mounted (1NC for fault alarm+1NO for Aux)	3	MMA01	1000
Fr-25 & Fr-80 MPCB Aux contact top mounted (1NO+1NC)	20	MMA02	1000
Fr-25 & Fr-80 MPCB Aux contact side mounted (1NO+1NC)	4	MMA03	1000
Fr-25 & Fr-80 MPCB Aux contact side mounted (2NO)	4	MMA04	1000



HI451I



HZC101I



HZE204I



VYE63M

Manual changeover switches

Characteristics:

- Comply with EN 60 947-3
- Manual changeover switches,
- Rating 63 to 100A
- Allows manual switch,
- changeover switch or on load
- power circuit permutation
- Connection with terminals
- For safety breaking:
- 4P
- mounting on perforated plates or crossbars
- lockable on position: I, O or II

Changeover switches

Description	Pack Qty.	Cat. Ref.	Unit MRP (₹)
63A	1	HI403I	7120
100A	1	HI405I	10400
125A	1	HI451I	15820
160A	1	HI452I	17360
250A	1	HI454I	29060
400A	1	HI456I	43070
630A	1	HI458I	52950
800A	1	HI460I	88390
1250A	1	HI462I	188540
1600A	1	HI464I	361500

* includes bridging bars & external handle

Description	Pack Qty.	Cat. Ref.	Unit MRP (₹)
External handle			
for HI 125 to 630A	1	HZI002I	1370
for HI 800 to 1600A	1	HZI003I	3040
Shaft extension			
for HI 125 to 630A, 200mm	1	HZC101I	570
for HI 125 to 630A, 320mm	1	HZC102I	720
for HI 800 to 1600A, 200mm	1	HZC105I	1760
for HI 800 to 1600A, 320mm	1	HZC106I	2080
Terminal shrouds			
for HI 125 to 200A	1	HZE202I	980
Top and bottom (2 pieces / packaging)			
for HI 200 to 400A	1	HZE204I	2170
for HI 400 to 630A	1	HZE206I	2560
Auxiliaries contacts			
for HI 125 to 1600A, 1NO + 1NC	1	HZ160I	970
Terminal shield			
for HI460I	1	HZ163MI	#
Top and bottom			
for HI462I and HI464I	1	HZ164MI	#

- Prices available upon request

MCOS enclosures

Characteristics:

- Rating: 63 – 1600A
- Changeover: 4P type
- Door: Hinged type single door
- Mounting: Surface type
- Preassembled with Manual COS
- Padlocking facility
- Removable gland plate
- Gasket protection

Description	Pack Qty.	Rating	Cat. Ref.	Unit MRP (₹)
63A FP MCOS Hinged Door Box	1	63A	▶ VYE63M	8740
100A FP MCOS Hinged Door Box	1	100A	▶ VYE100M	11520
125A FP MCOS Hinged Door Box	1	125A	▶ VYE125M	16550
160A FP MCOS Hinged Door Box	1	160A	▶ VYE160M	18130
250A FP MCOS Hinged Door Box	1	250A	▶ VYE250M	28440
400A FP MCOS Hinged Door Box	1	400A	VYE400M	43510
630A FP MCOS Hinged Door Box	1	630A	VYE630M	57570
800A FP MCOS Hinged Door Box	1	800A	VYE800M	94820



HIB412I

Automatic transfer switches

Characteristics:

- Motorized changeover switches
- Rating 125 to 1600A
- Allows automated switch, changeover switch or on load power circuit permutation
- For safety breaking
- 4P version
- Padlocking in OFF position
- Mounting on plain or perforated plate
- Controller HZI815I controls HIB switches
- Comply with NF EN 60 947-3

Motorized changeover switches (In)

Description	Pack Qty.	Cat. Ref.	Unit MRP (₹)
125A	1	HIB412I	67400
160A	1	HIB416I	80450
250A	1	HIB425I	97160
400A	1	HIB440I	119610
630A	1	HIB463I	156940
800A	1	HIB480I	229300
1000A	1	HIB490I	250900
1250A	1	HIB491I	418210

- * includes bridging bars & external handle
- * controller to be ordered separately

Automatic Transfer Relays

Description	Pack Qty.	Cat. Ref.	Unit MRP (₹)
Controller	1	HZI815I	28580

Terminal shrouds top and bottom (2 pieces / packaging)

Description	Pack Qty.	Cat. Ref.	Unit MRP (₹)
for switches 125 to 160A	1	HZC202I	980
for switches 200 to 400A	1	HZC204I	2170
for switches 400A to 630A	1	HZC206I	2560

Terminal covers

Description	Pack Qty.	Cat. Ref.	Unit MRP (₹)
for switches 125 to 160A	1	HZI201I	720
for switches 250 to 400A	1	HZI202I	970
for switches 630A	1	HZI203I	1120
for switches 800 to 1250A	1	HZI204I	1290
for switches 1600A	1	HZI205I	1760

HZI815I must be ordered along with Motorized changeover for Auto transfer switch to function

- Prices available upon request



EKS306B

SPN - Automatic changeover and current limiter

Characteristics:

- IEC 60947 - 3, IEC 60947 - 6
- SPN Modular
- Voltage: 150VAC to 300VAC
- 6000 Operations

- Blinking LED for overload and permanent
- LED for overload Trip
- Different LED colors for clear differentiation between functions

Description	Pack Qty.	Cat. Ref.	Unit MRP (₹)
Mains 30A, Genset 1.5A	1	▶ EKS301B	2700
Mains 30A, Genset 2.5A	1	▶ EKS302B	2700
Mains 30A, Genset 3A	1	▶ EKS303B	2700
Mains 30A, Genset 4A	1	EKS304B	2700
Mains 30A, Genset 5A	1	▶ EKS305B	2700
Mains 30A, Genset 6A	1	▶ EKS306B	2700
Mains 30A, Genset 9A	1	▶ EKS309B	2700
Mains 30A, Genset 12A	1	EKS312B	2700
Mains 30A, Genset 15A	1	EKS315B	2700
Mains 30A, Genset 20A	1	▶ EKS320B	2700
Mains 30A, Genset 30A (without current limiting)	1	▶ EKS330B	2700



EKT406SG

TPN - Automatic Changeover and Current Limiter

Characteristics:

- IEC 60947 - 6
- TPN / TPN & TPN / SPN
- Voltage: 150VAC to 300VAC

- 10000 Operations
- Genset Start / Stop as standard

TPN / SPN

Description	Pack Qty.	Cat. Ref.	Unit MRP (₹)
Mains 40A, Genset 6A	1	EKT406SG	14040
Mains 40A, Genset 10A	1	EKT410SG	14040
Mains 40A, Genset 16A	1	EKT416SG	14040
Mains 40A, Genset 20A	1	EKT420SG	14040
Mains 40A, Genset 25A	1	EKT425SG	14040
Mains 40A, Genset 30A	1	EKT430SG	14040
Mains 63A, Genset 6A	1	EKT606SG	20730
Mains 63A, Genset 10A	1	EKT610SG	20730
Mains 63A, Genset 16A	1	EKT616SG	20730
Mains 63A, Genset 20A	1	EKT620SG	20730
Mains 63A, Genset 25A	1	EKT625SG	20730
Mains 63A, Genset 30A	1	EKT630SG	20730
Mains 63A, Genset 40A	1	EKT640SG	20730

TPN / TPN

Description	Pack Qty.	Cat. Ref.	Unit MRP (₹)
Mains 40A, Genset 6A	1	EKT406TG	14710
Mains 40A, Genset 10A	1	EKT410TG	14710
Mains 40A, Genset 16A	1	EKT416TG	14710
Mains 40A, Genset 20A	1	EKT420TG	14710
Mains 40A, Genset 25A	1	EKT425TG	14710
Mains 40A, Genset 30A	1	EKT430TG	14710
Mains 63A, Genset 6A	1	EKT606TG	21390
Mains 63A, Genset 10A	1	EKT610TG	21390
Mains 63A, Genset 16A	1	EKT616TG	21390
Mains 63A, Genset 20A	1	EKT620TG	21390
Mains 63A, Genset 25A	1	EKT625TG	21390
Mains 63A, Genset 30A	1	EKT630TG	21390
Mains 63A, Genset 40A	1	EKT640TG	21390

TPN / TPN (without current limiting)

Description	Pack Qty.	Cat. Ref.	Unit MRP (₹)
Mains 40A, Genset 40A	1	▶ EKT440TG	14710
Mains 63A, Genset 63A	1	▶ EKT663TG	35430

*80/80A and 100/100A ACCL also available upon request



NCN106N



NCN206N



NCN306N



NCN406N

Miniature circuit breakers - type NBN---N, NCN---N

Characteristics:

- Conforms to IS/IEC 60898 - 1: IEC 60898
- Curve B & C
- 2P Suitable for 1P+N application; 4P Suitable for TP +N application
- 10 kA as per IEC 60898
- ISI Marked

Description	Pack Qty.	Cat. Ref. Curve B	Unit MRP (₹)	Cat. Ref. Curve C	Unit MRP (₹)
Single Pole					
0.5A, 1 module	12	-	-	NCN100N	640
1A, 1 module	12	-	-	NCN101N	640
2A, 1 module	12	-	-	NCN102N	640
3A, 1 module	12	-	-	NCN103N	640
4A, 1 module	12	-	-	NCN104N	640
6A, 1 module	12	NBN106N	410	NCN106N	400
10A, 1 module	12	NBN110N	410	NCN110N	400
16A, 1 module	12	NBN116N	410	NCN116N	400
20A, 1 module	12	NBN120N	410	NCN120N	400
25A, 1 module	12	NBN125N	410	NCN125N	400
32A, 1 module	12	NBN132N	410	NCN132N	400
40A, 1 module	12	NBN140N	890	NCN140N	910
50A, 1 module	12	NBN150N	890	NCN150N	910
63A, 1 module	12	NBN163N	890	NCN163N	910
Double Pole (Suitable for 1P+N application)					
0.5A, 2 module	6	-	-	NCN200N	1800
1A, 2 module	6	-	-	NCN201N	1800
2A, 2 module	6	-	-	NCN202N	1800
3A, 2 module	6	-	-	NCN203N	1800
4A, 2 module	6	-	-	NCN204N	1800
6A, 2 module	6	NBN206N	1260	NCN206N	1330
10A, 2 module	6	NBN210N	1260	NCN210N	1330
16A, 2 module	6	NBN216N	1260	NCN216N	1330
20A, 2 module	6	NBN220N	1260	NCN220N	1330
25A, 2 module	6	NBN225N	1260	NCN225N	1330
32A, 2 module	6	NBN232N	1260	NCN232N	1330
40A, 2 module	6	NBN240N	2020	NCN240N	2100
50A, 2 module	6	NBN250N	2020	NCN250N	2100
63A, 2 module	6	NBN263N	2020	NCN263N	2100
Triple Pole					
0.5A, 3 modules	4	-	-	NCN300N	2660
1A, 3 modules	4	-	-	NCN301N	2660
2A, 3 modules	4	-	-	NCN302N	2660
3A, 3 modules	4	-	-	NCN303N	2660
4A, 3 modules	4	-	-	NCN304N	2660
6A, 3 modules	4	NBN306N	2140	NCN306N	2130
10A, 3 modules	4	NBN310N	2140	NCN310N	2130
16A, 3 modules	4	NBN316N	2140	NCN316N	2130
20A, 3 modules	4	NBN320N	2140	NCN320N	2130
25A, 3 modules	4	NBN325N	2140	NCN325N	2130
32A, 3 modules	4	NBN332N	2140	NCN332N	2130
40A, 3 modules	4	NBN340N	3230	NCN340N	3240
50A, 3 modules	4	NBN350N	3230	NCN350N	3240
63A, 3 modules	4	NBN363N	3230	NCN363N	3240
Four Pole (Suitable for 3P+N application)					
0.5A, 4 modules	3	-	-	NCN400N	3310
1A, 4 modules	3	-	-	NCN401N	3310
2A, 4 modules	3	-	-	NCN402N	3310
3A, 4 modules	3	-	-	NCN403N	3310
4A, 4 modules	3	-	-	NCN404N	3310
6A, 4 modules	3	NBN406N	2750	NCN406N	2890
10A, 4 modules	3	NBN410N	2750	NCN410N	2890
16A, 4 modules	3	NBN416N	2750	NCN416N	2890
20A, 4 modules	3	NBN420N	2750	NCN420N	2890
25A, 4 modules	3	NBN425N	2750	NCN425N	2890
32A, 4 modules	3	NBN432N	2750	NCN432N	2890
40A, 4 modules	3	NBN440N	3960	NCN440N	4120
50A, 4 modules	3	NBN450N	3960	NCN450N	4120
63A, 4 modules	3	NBN463N	3960	NCN463N	4120



NDN106N



NDN206N



NDN306N



NDN406N

Miniature circuit breakers - type NDN---N

Characteristics:

- Conforms to IS/IEC 60898 - 1:2002, IEC 60898 - 1995
 - Curve D

- 10 kA as per IEC 60898
 - ISI Marked

Description	Pack Qty.	Cat. Ref. Curve D	Unit MRP (₹)
Single Pole			
0.5A, 1 module	12	NDN100N	650
1A, 1 module	12	NDN101N	650
2A, 1 module	12	NDN102N	650
3A, 1 module	12	NDN103N	650
4A, 1 module	12	NDN104N	650
6A, 1 module	12	NDN106N	560
10A, 1 module	12	NDN110N	560
16A, 1 module	12	NDN116N	560
20A, 1 module	12	NDN120N	560
25A, 1 module	12	NDN125N	560
32A, 1 module	12	NDN132N	560
40A, 1 module	12	NDN140N	1000
50A, 1 module	12	NDN150N	1000
63A, 1 module	12	NDN163N	1000
Double Pole (Suitable for 1P+N application)			
0.5A, 2 modules	6	NDN200N	1830
1A, 2 modules	6	NDN201N	1830
2A, 2 modules	6	NDN202N	1830
3A, 2 modules	6	NDN203N	1830
4A, 2 modules	6	NDN204N	1830
6A, 2 modules	6	▶ NDN206N	1360
10A, 2 modules	6	NDN210N	1360
16A, 2 modules	6	▶ NDN216N	1360
20A, 2 modules	6	▶ NDN220N	1360
25A, 2 modules	6	▶ NDN225N	1360
32A, 2 modules	6	▶ NDN232N	1360
40A, 2 modules	6	▶ NDN240N	2240
50A, 2 modules	6	NDN250N	2240
63A, 2 modules	6	▶ NDN263N	2240
Triple Pole			
0.5A, 3 modules	4	NDN300N	2740
1A, 3 modules	4	NDN301N	2740
2A, 3 modules	4	NDN302N	2740
3A, 3 modules	4	NDN303N	2740
4A, 3 modules	4	NDN304N	2740
6A, 3 modules	4	NDN306N	2210
10A, 3 modules	4	NDN310N	2210
16A, 3 modules	4	NDN316N	2210
20A, 3 modules	4	NDN320N	2210
25A, 3 modules	4	NDN325N	2210
32A, 3 modules	4	▶ NDN332N	2210
40A, 3 modules	4	▶ NDN340N	3380
50A, 3 modules	4	NDN350N	3380
63A, 3 modules	4	▶ NDN363N	3380
Four Pole (Suitable for 3P+N application)			
0.5A, 4 modules	3	NDN400N	3370
1A, 4 modules	3	NDN401N	3370
2A, 4 modules	3	NDN402N	3370
3A, 4 modules	3	NDN403N	3370
4A, 4 modules	3	NDN404N	3370
6A, 4 modules	3	NDN406N	2930
10A, 4 modules	3	NDN410N	2930
16A, 4 modules	3	NDN416N	2930
20A, 4 modules	3	NDN420N	2930
25A, 4 modules	3	NDN425N	2930
32A, 4 modules	3	▶ NDN432N	2930
40A, 4 modules	3	▶ NDN440N	4370
50A, 4 modules	3	NDN450N	4370
63A, 4 modules	3	▶ NDN463N	4370



MZ215

Accessories for MCBs, RCCBs & RCBOs

Description	Pack Qty.	Cat. Ref.	Unit MRP (₹)
Auxiliary contact (1NO + 1NC), 0.5 module (For MCBs only)	1	▶ MZ201	1590
Trip alarm contact (1NO + 1NC), 0.5 module (For MCBs only)	1	▶ MZ202	1880
Shunt trip 230V AC, 1 module	1	▶ MZ203	4590
Shunt trip 12-48V DC, 1 module	1	MZ204	4590
Undervoltage release, 230V AC, 1 module	1	▶ MZ206	3930
MCB Locking kit	2	MZN175	910
Auxiliary + alarm switch (for RCCB), 1 module	1	▶ CZ001	3010
Overvoltage release, 230V AC, $U_c > 280V$, 1 module	1	▶ MZ209	4630
Overvoltage + Low voltage release, 230V AC, $60V AC < U < 170V AC$, $U > 267V AC$, 1 module	1	▶ MZ215	6240
Overvoltage release, 230V AC, $U > 275 V AC$, 3 phase in 1 module Suitable for 3Ph+N	1	▶ MZ216	8340

Use of MZ203/204/205/206/209/215/216 on RCCBs require use of interface auxiliary CZ001



CD240Y

RCCBs

Characteristics:

- Conforms to IEC 61008
- IS12640-1
- ISI Marked

- Protects a circuit automatically in the event of an earth leakage
- With earth fault indicator & positive contact indication

Description	Pack Qty.	Sensitivity	Cat. Ref.	Unit MRP (₹)
Double Pole				
16A, 2 modules	1	10 mA	CC216Y	10400
25A, 2 modules	1	10 mA	CC225Y	11930
	1	30 mA	CD225Y	4410
	1	100 mA	CE225Y	4940
	1	300 mA	CF225Y	4960
40A, 2 modules	1	30 mA	CD240Y	5160
	1	100 mA	CE240Y	5570
	1	300 mA	CF240Y	5750
63A, 2 modules	1	30 mA	CD263Y	6240
	1	100 mA	CE263Y	6740
	1	300 mA	CF263Y	6790
100A, 2 modules	1	30 mA	CDC284Y	16960
	1	300 mA	CEC284Y	16960



CD440Y

Four Pole

25A, 4 modules	1	30 mA	CD425Y	6230
	1	100 mA	CE425Y	6490
	1	300 mA	CF425Y	6620
40A, 4 modules	1	30 mA	CD440Y	6100
	1	100 mA	CE440Y	6530
	1	300 mA	CF440Y	6740
63A, 4 modules	1	30 mA	CD463Y	6910
	1	100 mA	CE463Y	7780
	1	300 mA	CF463Y	7780
100A, 4 modules	1	30 mA	CDC484Y	17120
	1	100 mA	CEC484Y	17120
	1	300 mA	CFC484Y	17390



CH240J

RCCBs - type Hi (high immunity)

Characteristics:

- Conforms to IEC 61008 & EMC standard EN 61543
- For electrical networks with high harmonics / pulsated DC currents and transients

- With earth fault indicator & positive contact indication

Description	Pack Qty.	Sensitivity	Cat. Ref.	Unit MRP (₹)
Double Pole				
25A, 2 modules	1	30 mA	▶ CH225J	9510
	1	300 mA	CQ225J	9160
40A, 2 modules	1	30 mA	▶ CH240J	9900
	1	300 mA	▶ CQ240J	9480
63A, 2 modules	1	30 mA	▶ CH263J	10190
	1	300 mA	▶ CQ263J	9980



CH440J

Four Pole

25A, 4 modules	1	30 mA	CH425J	10710
	1	300 mA	CQ425J	10180
40A, 4 modules	1	30 mA	▶ CH440J	11060
	1	300 mA	CQ440J	10610
63A, 4 modules	1	30 mA	CH463J	11250
	1	300 mA	CQ463J	10940



AD956Y

RCBOs - 2 pole 2 modules

Characteristics:

- Conforms to IEC 61009
- Breaking capacity 6kA

- Two pole compact device for overload, short-circuit and
- earth leakage protection, with earth fault indicator

Description	Pack Qty.	Sensitivity	Cat. Ref.	Unit MRP (₹)
Double Pole				
6A, 2 modules	1	30 mA	▶ AD956Y	6670
	1	100mA	▶ AE956Y	6810
	1	300 mA	▶ AF956Y	7060
10A, 2 modules	1	30 mA	▶ AD960Y	6670
	1	100mA	▶ AE960Y	6810
	1	300 mA	▶ AF960Y	7060
16A, 2 modules	1	30 mA	▶ AD966Y	6670
	1	100 mA	▶ AE966Y	6810
	1	300 mA	▶ AF966Y	7060
20A, 2 modules	1	30 mA	▶ AD970Y	6670
	1	100 mA	▶ AE970Y	6810
	1	300 mA	▶ AF970Y	7060
25A, 2 modules	1	30 mA	▶ AD975Y	6670
	1	100mA	▶ AE975Y	6810
	1	300 mA	▶ AF975Y	7060
32A, 2 modules	1	30 mA	▶ AD982Y	7020
	1	100mA	▶ AE982Y	7000
	1	300 mA	▶ AF982Y	7430
40A, 2 modules	1	30 mA	▶ AD990Y	8320
	1	100mA	▶ AE990Y	8510
	1	300 mA	▶ AF990Y	8370



ADH975

RCBOs - type Hi (high immunity)

Characteristics:

- Conforms to IEC 61009
- Breaking capacity 6kA

- For electrical networks with high harmonics / pulsated
- DC components with earth fault indicator

Description	Pack Qty.	Sensitivity	Cat. Ref.	Unit MRP (₹)
Double Pole				
6A, 2 modules	1	30 mA	▶ ADH956	12070
	1	300 mA	▶ AFH956	12770
10A, 2 modules	1	30 mA	▶ ADH960	12070
	1	300 mA	▶ AFH960	12770
16A, 2 modules	1	30 mA	▶ ADH966	12070
	1	300 mA	▶ AFH966	12770
20A, 2 modules	1	30 mA	▶ ADH970	12070
	1	300 mA	▶ AFH970	12770
25A, 2 modules	1	30 mA	▶ ADH975	12070
	1	300 mA	▶ AFH975	12770
32A, 2 modules	1	30 mA	▶ ADH982	13670
40A, 2 modules	1	30 mA	▶ ADH990	16130

Protection devices

RCBO, RCD+MCB modules



ADC225Y

RCBO, RCD+MCB modules

Characteristics:

- Conforms to IEC 61009-1
- Breaking capacity 10kA
- CE / ISI Marked
- RoHS compliant

- Type AC
- Two pole and four pole device for overload, short-circuit and earth leakage protection, with earth fault indicator

Description	Pack Qty.	Sensitivity	Cat. Ref.	Unit MRP (₹)
Double Pole				
6A, 4 modules	1	30 mA	▶ ADC206Y	5440
	1	100 mA	AEC206Y	6770
10A, 4 modules	1	30 mA	▶ ADC210Y	5640
	1	100 mA	AEC210Y	6770
16A, 4 modules	1	30 mA	▶ ADC216Y	5210
	1	100 mA	▶ AEC216Y	6510
	1	300 mA	AFC216Y	6730
25A, 4 modules	1	30 mA	▶ ADC225Y	5370
	1	100 mA	▶ AEC225Y	6830
	1	300 mA	AFC225Y	7200
32A, 4 modules	1	30 mA	▶ ADC232Y	5700
	1	100 mA	▶ AEC232Y	6670
	1	300 mA	AFC232Y	6960
40A, 4 modules	1	30 mA	▶ ADC240Y	6780
	1	100 mA	▶ AEC240Y	7500
	1	300 mA	▶ AFC240Y	7710
63A, 4 modules	1	30 mA	▶ ADC263Y	8670
	1	100 mA	AEC263Y	9280
	1	300 mA	AFC263Y	9430



ADC425Y

Four Pole				
16A, 6 modules	1	30 mA	▶ ADC416Y	7340
	1	100 mA	▶ AEC416Y	8270
	1	300 mA	AFC416Y	8530
25A, 6 modules	1	30 mA	▶ ADC425Y	7850
	1	100 mA	▶ AEC425Y	8470
	1	300 mA	▶ AFC425Y	8800
32A, 7 modules	1	30 mA	▶ ADC432Y	7570
	1	100 mA	▶ AEC432Y	8260
	1	300 mA	▶ AFC432Y	8510
40A, 7 modules	1	30 mA	▶ ADC440Y	7680
	1	100 mA	▶ AEC440Y	8370
	1	300 mA	▶ AFC440Y	8400
63A, 7 modules	1	30 mA	▶ ADC463Y	9460
	1	100 mA	AEC463Y	9960
	1	300 mA	AFC463Y	10140



LS501

HRC fuse carriers

Characteristics:

- Conforms to IEC 60269 - 2
- IEC 60269 - 2 - 1
- IEC 60947 - 3
- Description
- Protection and control of circuits against overloads and short circuits.
- Technical data
- sizes : L38, L51
- poles : 1P, 2P
- voltage rating : 500 V AC, 690V AC
- current rating : 32 to 50A
- frequency : 50/60Hz
- climate sealed : T2
- short circuit resistance with fuse link 10.3 x 38 mm :
 - 80kA – 690V~/
 - 120kA – 500 V~
- short circuit resistance with fuse link 14x51 mm :
 - 100kA – 690V
- Connection capacity
- L38 (10x38) :
 - rigid conductors : 25mm²
 - flexible conductors : 16mm²
- L51 (14x51) :
 - rigid conductors : 35mm²
 - flexible conductors : 25mm²

Description	Pack Qty.	Characteristics	Cat. Ref.	Unit MRP (₹)
L38 fuse carriers 690V - 32A	12	Single Pole	▶ LSN501	440
	6	Double Pole	LSN502	730
L51 fuse carriers 690V - 32A	1	Single Pole	LS601	1610
	1	Double Pole	LS602	3330



LF302G

HRC cartridge fuses - gG type

Description	Pack Qty.	Characteristics	Amp Rating	Cat. Ref.	Unit MRP (₹)
Cartridge fuses type gG 10 x 38 mm breaking capacity: 120kA	10	500 V AC	1A	▶ LF301G	90
	10		2A	▶ LF302G	90
	10		4A	▶ LF304G	90
	10		6A	▶ LF306G	90
	10		10A	▶ LF310G	90
	10		12A	▶ LF312G	90
	10		16A	▶ LF316G	90
	10		20A	▶ LF320G	90
	10		25A	▶ LF325G	90
	10	400 V AC	32A	LF332G	100
Cartridge fuses type gG 14 x 51 mm breaking capacity: 2 to 25A : 80kA 32 to 50A : 120kA	10	690 V AC	6A	LF406G	170
	10	500 V AC	32A	LF432G	170
	10		40A	LF440G	170
	10	400 V AC	50A	LF450G	220



SPL465R

Surge protection devices

Characteristics:

- Conforms to IEC 61643 - 1
- IEC 61643 - 11

- Protects electronic equipments against transient voltage surges caused by lightning or switching of motors, transformers etc.

Description	Pack Qty.	Characteristics	Cat. Ref.	Unit MRP (₹)
Type 1 + 2 products-main protection				
Imax 12.5kA (Remote Signaling)	1	2P T1+T2 TNS/TT	▶ SPL212R	16070
Imax 12.5kA (Remote Signaling)	1	4P T1+T2 TNS/TT	▶ SPL412R	32170
Type 2 products-main protection				
Imax 20kA	1	2P T2 TNS/TT	▶ SPL220	8910
Imax 20kA	1	4P T2 TNS/TT	▶ SPL420	16940
Imax 40kA	1	2P T2 TNS/TT	▶ SPL240	10510
Imax 40kA	1	4P T2 TNS/TT	▶ SPL440	20640
Imax 65kA (Remote Signaling)	1	2P T2 TNS/TT	SPL265R	17970
Imax 65kA (Remote Signaling)	1	4P T2 TNS/TT	▶ SPL465R	35680
Phase cartridges for				
	1	SPL220/SPL420	SPL020	2890
	1	SPL240/SPL440	SPL040	3550
	1	SPL265R/SPL465R	SPL065	4240
Neutral cartridges for				
	1	SPL240/SPL440	SPL040N	5660
	1	SPL265R/SPL465R	SPL065N	6780



SFT240N

2 way centre off changeover switches

Characteristics:

- Allows changeover from electricity boards supply to generator supply & vice-versa

Description	Pack Qty.	Cat. Ref.	Unit MRP (₹)
Double Pole			
25A, 2 modules	1	▶ SFT225N	3200
40A, 2 modules	1	▶ SFT240N	4880
63A, 4 modules		▶ SF263	5180
Four Pole			
40A, 4 modules	1	▶ SFT440N	7860
63A, 8 modules	1	▶ SF463	8640



SBN225N

Isolating switches

Characteristics:

- Conforms to IEC 60947-III

- AC22A devices used as switch disconnectors in electrical circuit

Description	Pack Qty.	Cat. Ref. Curve C	Unit MRP (₹)
Single Pole			
16A, 1 modules	1	SBN116N	640
Double Pole			
25A, 1 module	1	▶ SBN225N	680
32A, 1 module	1	SBN232N	740
40A, 2 modules	1	▶ SBN240N	750
63A, 2 modules	1	▶ SBN263N	1000
100A, 2 modules	1	SBN290N	1430
125A, 2 modules	1	SBN299N	1630
Triple Pole			
32A, 2 module	1	▶ SBN332N	1320
40A, 3 modules	1	▶ SBN340N	1370
63A, 3 modules	1	▶ SBN363N	1600
100A, 3 modules	1	▶ SBN390N	1910
125A, 3 modules	1	SBN399N	2200
Four Pole			
32A, 2 module	1	▶ SBN432N	1470
40A, 4 modules	1	▶ SBN440N	1680
63A, 4 modules	1	▶ SBN463N	1870
100A, 4 modules	1	▶ SBN490N	2340
125A, 4 modules	1	▶ SBN499N	2620



SBN440N



MFM Characteristics :

- Password Protection
- Class 0.5 Accuracy
- 31st order THD (available in Power Analyzer)
- Backlight LCD display
- Demand Controller with Contact
- RS485 communication

Description	Pack Qty.	Cat.Ref.	Unit MRP(₹)
Single Phase Ammeter LED	1	SMHMA7001EWH	1,160
Single Phase Volt Meter LED	1	SMHMOV7001EWH	1,160
Three Phase Amp Meter LED	1	SMHMA7003EWH	1,900
Three Phase Volt Meter LED	1	SMHMOV7003EWH	1,900
VAF Meter LED	1	SMHME8003EWM	2,380
Energy MFM LED + RS485	1	SMHME8003EWH	6,500
Energy MFM LCD + RS485	1	SMHME8003CWH	6,500
Power analyser Dual Source LCD+ RS485	1	SMHMP9003EWH	10,000
Power analyser Dual Source LCD+ RS485	1	SMHMP9003CWH	11,250

Voltage protection relay Characteristics:

- PUnder voltage/Over voltage/phase reversal Protection
- Fault and Healthiness Annunciation
- 3P/3W and 3P/4W versions
- Potential Free Contact for CB operation
- Din rail Mounting
- Demand Controller with Contact
- RS485 communication



Description	Pack Qty.	Cat.Ref.	Unit MRP(₹)
CT 25/5A CL1	1	SRHCX0025BHM	620
CT 50/5A CL1	1	SRHCX0050BHM	620
CT 75/5A CL1	1	SRHCX0075BHM	620
CT 100/5A CL1	1	SRHCX0100BHM	620
CT 150/5A CL1	1	SRHCX0150BHM	600
CT 200/5A CL1	1	SRHCX0200BHM	600
CT 250/5A CL1	1	SRHCX0250BHM	600
CT 300/5A CL1	1	SRHCX0300BHM	680
CT 400/5A CL1	1	SRHCX0400BHM	680
CT 450/5A CL1	1	SRHCX0450BHM	720
CT 500/5A CL1	1	SRHCX0500BHM	720
CT 600/5A CL1	1	SRHCX0600BHM	720
CT 800/5A CL1	1	SRHCX0800BHM	950
CT 1000/5A CL1	1	SRHCX1000BHM	1,040
CT 1250/5A CL1	1	SRHCX1250BHM	1,210
CT 1600/5A CL1	1	SRHCX1600BHM	1,300
CT 2000/5A CL1	1	SRHCX2000BHM	1,300
CT 2500/5A CL1	1	SRHCX2500BHM	1,620
CT 3000/5A CL1	1	SRHCX3000BHM	1,750
CT 4000/5A CL1	1	SRHCX4000BHM	2,110



Timer Characteristics:

- Use settable Delay for Suitable Automation
- Relay and Power operation annunciation through LED
- High operational endurance
- Din rail Mounting

Description	Pack Qty.	Cat.Ref.	Unit MRP(₹)
VOLTAGE PROTECTION RELAY 3P/3W	1	EUHRVP33D	1,990
VOLTAGE PROTECTION RELAY 3P/4W	1	EUHRVP34D	1,990
Timer STAR DELTA	1	EZHSD00D	1,880
Timer MULTIFUNCTION	1	EZHMF00D	1,960
Timer CYCLIC	1	EZHCY00D	1,960
Timer ON DELAY	1	EZHOD00D	990

:hager

Time to switch.

The Time Switches Range
from Hager

:hager

Energy & Lighting Control

Hager offers innovative solutions for efficient use of available resources to keep energy consumption at lowest with higher control, comfort and convenience to users. Hager's lighting control devices are totally unique and provides real benefits to end users.



Indicator lights	72
Push buttons	72
Modular contactors	72
Time switches	73
Twilight switches	74
Movement & presence detectors	75
Movement detector-wall mounted	75
Accessories for movement & presence detectors	75



SVN126

Indicating lights (LED)

Characteristics:

- Modular LED indicating lights for remote signalling of status of an electrical circuit

Description	Pack Qty.	Cat. Ref.	Unit MRP (₹)
Green, 1 module	12	SVN121	1110
Red, 1 module	12	SVN122	1110
Orange, 1 module	12	SVN123	1110
Blue, 1 module	12	SVN124	1110
Red+Green indicator, 1 module	12	SVN126	1430
Red+Green+Orange indicator, 1 module	12	SVN129	1580
Red+Orange+Blue (RYB) indicator, 1 module	12	SVN222	2080



SVN312

Push buttons

Characteristics:

- Latching push buttons for actuating loads directly or via contactors

Description	Pack Qty.	Cat. Ref.	Unit MRP (₹)
16A without indicator			
1NO, 1 module	1	SVN312	1510
2NO, 1 module	1	SVN332	1550
1NO + 1NC, 1 module	1	SVN352	1550

Description	Pack Qty.	Cat. Ref.	Unit MRP (₹)
16A with green indicator			
1NO, 1 module	1	SVN413	2140



ESC463

Contactors

Characteristics:

- All contactor ratings are for AC 7A load only (Coil voltage 230V 50Hz) - For remote switching & control of power circuits

Description	Pack Qty.	Cat. Ref.	Unit MRP (₹)
Type 1 products-main protection			
2 NO, 25A, 1 module	1	▶ ESC225	2930
1 NO+1NC, 25A, 1 module	1	ESC227	3250
2 NO, 40A, 3 modules	1	▶ ESC240	5200
2 NO, 63A, 3 modules	1	ESC263	7090
3 NO, 40A, 3 modules	1	ESC340	7110
3 NO, 63A, 3 modules	1	ESC363	9210
4 NO, 25A, 3 modules	1	ESC425	4660
4 NO, 40A, 3 modules	1	▶ ESC440	8390
2 NO+2NC, 40A, 3 modules	1	ESC442	7810
3 NO+1NC, 40A, 3 modules	1	ESC443	7590
4 NO, 63A, 3 modules	1	▶ ESC463	10190
2NO+2NC, 63A, 3 modules	1	ESC465	9110
3NO+1NC, 63A, 3 modules	1	ESC466	8030
Auxiliary contact 1NO+1NC	1	ESC080	2840

Electromechanical time switches

Characteristics:

- Complies with EN 60 730
- Contact Rating: 16A AC1
- Programming using captive segments

- These devices are used to control lighting & ventilation circuits based upon real time

Description	Pack Qty.	Cat. Ref.	Unit MRP (₹)
Quartz 1 channel 1 daily dial 1 module	1	EHN011	3665
Quartz 1 channel 1 daily dial 3 modules	1	EHN111	3940

Detection Solutions



EE805A

Movement and presence detectors

Characteristics:

- Day light sensing.
- Surface and flush mounting versions
- Adjustable time delay and lux level settings
- Movement detectors
- - Inbuilt ambient light sensor with adjustable lux level 5 to 1000 lux
- - adjustable time delay upto 30 mins

Description	Pack Qty.	Cat. Ref.	Unit MRP (₹)
Single lens, 360°, 6m dia detection 10A AC 1, 1 channel, surface mounted	1	EE804A	5275
Single lens, 360°, 6m dia detection 10A AC 1, 1 channel, flush mounted	1	EE805A	5275

Sensors & Detectors

Zero-crossing contact PIR Presence/motion detector

Zero-crossing contact PIR Presence/motion detector

Characteristics
 Zero-crossing contact
 PIR Presence/motion detector



EER501

Description	Pack Qty.	Cat.Ref.	Unit MRP(₹)
Single lens, 360°, 20m detection 10A AC 1,1 channel, flush mount mounted	1	EER501	10270



EER505

Single lens, 360°, 20m dia detection 10A AC 1,1 channel, flush mounted	1	EER503	11230
Single lens, 360°, 30x5m detection 10A AC 1,1 channel, flush mounted.	1	EER505	11185



EER513

Single lens, 360°, 20m dia detection 10A AC 1, 1 channel, surface mounted	1	EER513	11230
Single lens, 360°, 10A AC 1, 1 channel, surface mounted for Corridor	1	EER515	11185
Single lens, 360°, 10A AC 1, 1 channel, surface mounted for HighBay	1	EER518	12690

Wiring Accessories

insysta range of wiring accessories is tailor made to suit the requirement of Indian customers. The comprehensive range offers "AX" rated switches to switch inductive loads without derating the switches. insysta switches can be front loaded & removed, thus giving easy access when maintenance is required. The sockets & fan regulators are tested & conform to ISI standards and is marked giving utmost confidence to the users.

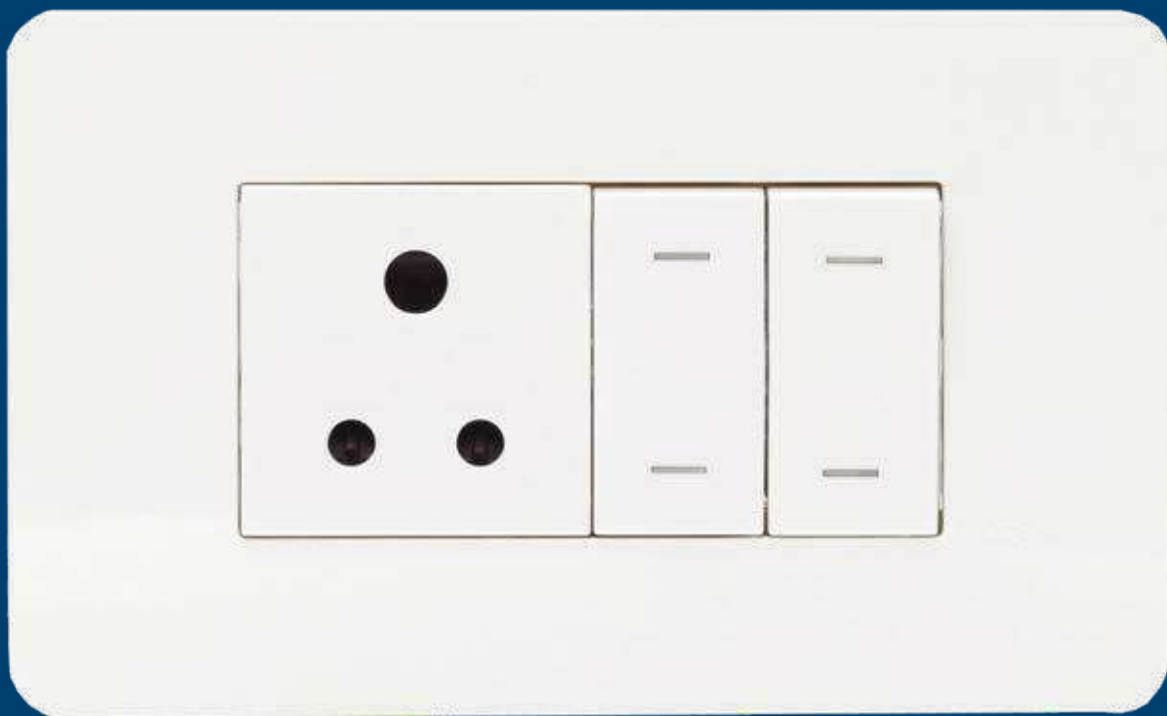

6AX switches	78
10AX switches	78
16AX switches	78
20AX switches	78
20A / 32A Double Pole switches	78
Push button	79
Sockets	79
Regulators & dimmers	79
Data sockets	80
VDI module & accessories	80
USB socket	80
Cover & grid plates - Plastic	80
Cover plates - Real material	80
Grid plates - Real material	81
Wall Boxes	81



WSNSW11

insysta™ 6AX switches

Description	Module size	Cat. Ref.	Unit MRP (₹)
1 way glossy white	1	WSNSW11	170
1 way glossy white with LED	1	WSNSL11	270
1 way anthracite	1	WSNSW11A	210
1 way anthracite with LED	1	WSNSL11A	330
2 way glossy white	1	WSNSW21	250
2 way anthracite	1	WSNSW21A	290



WSNSW31

insysta™ 10AX switches

Description	Module size	Cat. Ref.	Unit MRP (₹)
1 way glossy white	1	WSNSW31	220
1 way anthracite	1	WSNSW31A	260



WSNSW61

insysta™ 16AX switches

Description	Module size	Cat. Ref.	Unit MRP (₹)
1 way glossy white	1	WSNSW51	330
1 way glossy white with LED	1	WSNSL51	310
1 way anthracite	1	WSNSW51A	350
1 way anthracite with LED	1	WSNSL51A	380
2 way glossy white	1	WSNSW61	350
2 way anthracite	1	WSNSW61A	420



WSNSL71

insysta™ 20AX switches

Description	Module size	Cat. Ref.	Unit MRP (₹)
1 way glossy white	1	WSNSW71	320
1 way glossy white with LED	1	WSNSL71	340
1 way anthracite	1	WSNSW71A	380
1 way anthracite with LED	1	WSNSL71A	400



WSNSW81

insysta™ 20A / 32A Double Pole switches with LED

Description	Module size	Cat. Ref.	Unit MRP (₹)
20A DP 1 way glossy white	2	WSNSW81	690
20A DP 1 way anthracite	2	WSNSW81A	830
32A DP 1 way glossy white	2	WSNSW92	985
32A DP 1 way anthracite	2	WSNSW92A	1180



WSNBP11

insysta™ Push button

Description	Module size	Cat. Ref.	Unit MRP (₹)
6A glossy white	1	WSNBP11	250
6A glossy white with Indicator	1	WSNBP21	340
6A glossy white	2	WSNBP12	360
6A glossy white with Indicator	2	WSNBP22	440
6A anthracite	1	WSNBP11A	300
6A anthracite with Indicator	1	WSNBP21A	400
6A anthracite	2	WSNBP12A	440
6A anthracite with Indicator	2	WSNBP22A	530



WSNSK42

insysta™ Sockets

Description	Module size	Cat. Ref.	Unit MRP (₹)
6 / 16A glossy white Protruded	2	WSNSK42	420
6 / 16A glossy white	3	WSNSK53	510
6 / 16A anthracite Protruded	2	WSNSK42A	510
6 / 16A anthracite	3	WSNSK53A	630
6A Indian socket glossy white	2	WSNSK72	300
6A Indian socket anthracite	2	WSNSK72A	410



WSNFC22

insysta™ Regulators & dimmers

Description	Module size	Cat. Ref.	Unit MRP (₹)
100W glossy white fan regulator	1	WSNFC11	870
120W glossy white fan regulator	2	WSNFC22	1170
400W glossy white incandescent rotary dimmer	1	WSNDM11	1060
1000W glossy white incandescent rotary dimmer	2	WSNDM22	2100
100W anthracite fan regulator	1	WSNFC11A	1020
120W anthracite fan regulator	2	WSNFC22A	1390
400W anthracite incandescent rotary dimmer	1	WSNDM11A	1260
1000W anthracite incandescent rotary dimmer	2	WSNDM22A	2520



WSNDS11

insysta™ Data sockets

Description	Module size	Cat. Ref.	Unit MRP (₹)
glossy white RJ11 single	1	WSNDS11	270
glossy white RJ11 twin	1	WSNDS21	380
glossy white RJ45 cat 5e	1	WSNDS31	690
glossy white RJ45 cat 6	1	WSNDS41	800
anthracite RJ11 single	1	WSNDS11A	340
anthracite RJ11 twin	1	WSNDS21A	450
anthracite RJ45 cat 5e	1	WSNDS31A	830
anthracite RJ45 cat 6	1	WSNDS41A	960



WSNDT11



WSNDT31

insysta™ VDI module & accessories

Description	Module size	Cat. Ref.	Unit MRP (₹)
glossy white HDMI Port	1	WSNDT21	1990
glossy white 3x female RCA AV Connector	1	WSNDT31	2680
glossy white female HD VGA 15AV Connector	1	WSNDT42	3450
glossy white Co-Axial TV socket	1	WSNDT11	220
glossy white cord outlet	1	WSNDS71	300
glossy white blanking plate	1	WSNBK11	50
anthracite HDMI Port	1	WSNDT21A	2390
anthracite 3x female RCA AV Connector	1	WSNDT31A	3150
anthracite female HD VGA 15AV Connector	1	WSNDT42A	4070
anthracite Co-Axial TV socket	1	WSNDT11A	270
anthracite cord outlet	1	WSNDS71A	360
anthracite blanking plate	1	WSNBK11A	60



WSNDS51

insysta™ USB sockets

Description	Module size	Cat. Ref.	Unit MRP (₹)
glossy white USB Port	1	WSNDS51	1600
anthracite USB Port	1	WSNDS51A	1910
2A glossy white USB charger	1	WSNDS61	2840
2A anthracite USB charger	1	WSNDS61A	3230

- For charging purpose please select USB charger. USB ports to be used for data transfer.



WSNCG1

insysta™ Cover plates - Plastic

Pack qty.	Module size	Glossy white		Anthracite (Dark Gray)	
		Cat. Ref.	Unit MRP (₹)	Cat. Ref.	Unit MRP (₹)
15	1	WSNCG1	170	WSNCG1A	300
15	2	WSNCG2	170	WSNCG2A	320
10	3	WSNCG3	200	WSNCG3A	340
10	4	WSNCG4	200	WSNCG4A	390
5	6	WSNCG6	380	WSNCG6A	650
5	8	WSNCG8	450	WSNCG8A	720
5	8	WSNCGS8	530	WSNCGS8A	940
5	12	WSNCG12	670	WSNCG12A	1220
5	18	WSNCG18	910	WSNCG18A	1610



WSNCG1GW

insysta™ Cover plates - Real material

Pack qty.	Module size	White glass		Black glass	
		Cat. Ref.	Unit MRP (₹)	Cat. Ref.	Unit MRP (₹)
1	1	WSNCG1GW	2110	WSNCG1GB	2180
1	2	WSNCG2GW	2380	WSNCG2GB	2440
1	3	WSNCG3GW	3020	WSNCG3GB	3080
1	4	WSNCG4GW	3110	WSNCG4GB	3170
1	6	WSNCG6GW	4360	WSNCG6GB	4430
1	8	WSNCG8GW	5220	WSNCG8GB	5140
1	8	WSNCGS8GW	5210	WSNCGS8GB	5270
1	12	WSNCG12GW	5880	WSNCG12GB	5950



WSNG3

insysta™ Grid plates - Real material

Description	Pack qty.	Module size	Cat. Ref.	Unit MRP (₹)
Grid Plate - 1 module	1	1	WSNG1	100
Grid Plate - 2 module	1	2	WSNG2	100
Grid Plate - 3 module	1	3	WSNG3	110
Grid Plate - 4 module	1	4	WSNG4	150
Grid Plate - 6 module	1	6	WSNG6	210
Grid Plate - 8 module (Horizontal)	1	8	WSNG8	250
Grid Plate - 8 module (Square)	1	8	WSNG8S	259
Grid Plate - 12 module	1	12	WSNG12	380



WSNMB3

insysta™ Wall boxes

Description	Pack qty.	Module size	Cat. Ref.	Unit MRP (₹)
Metal Mounting Boxes 1 & 2	60	2	WSNMB2	130
Metal Mounting Boxes 3 module	45	3	WSNMB3	130
Metal Mounting Boxes 4 module	30	4	WSNMB4	170
Metal Mounting Boxes 6 module	20	6	WSNMB6	260
Metal Mounting Boxes 8 module (Horizontal)	15	8	WSNMB8H	310
Metal Mounting Boxes 8 module (Square)	24	8	WSNMB8R	310
Metal Mounting Boxes 12 module	16	12	WSNMB12	470
Metal Mounting Boxes 18 module	10	18	WSNMB18	590

Dispatch lead time for non-stockable references:

- MCBs / RCCBs / RCBOs - 2 weeks
- novello⁺ distribution boards - 4 - 6 weeks
- golf, vector enclosures & MCCBs - 8 weeks
- Manual changeover switches - 4 - 6 weeks
- Automatic transfer switches - 6 - 8 weeks
- Others - 4 - 6 weeks
- The above delivery lead times are subject to change without prior notice. Please contact your nearest Sales representative / Office for latest delivery lead times.

Terms & Conditions

- Price means Maximum Retail Price (M.R.P).
- This price list supercedes all previous price list.
- Price is in Indian Rupees (₹) and inclusive of GST / taxes / duties as applicable.
- Delivery term is "Door Delivery".
- Prices are subject to revision without notice. All dispatch will be as per price prevailing on the date of invoice.
- Enclosures / Distribution Boards have the provision for fixing the component as shown in the photograph.
- For all Insysta Color reference and real material, minimum ordering quantity will be applicable. Please connect with sales representative for details regarding MOQ.
- All the products listed in the price list carry a warranty, against manufacturing defects for a period of 24 months from the date of invoicing.
- The warranty is however subject to proper usage and maintenance and does not cover defects arising out of improper installation, inefficient maintenance, faulty operation and willful or accidental damage including nonperformance, which is caused by an event constituting Force Majeure, i.e. including (but not limited to) pandemic, fire, floods, administrative orders etc.
- Hager and / or manufacturer shall not be liable for any consequential loss, including personal injury or damages arising out of, or in connection with, defects in the Products including claim by third party.
- Proof of purchase to be retained to avail warranty.

Always near

North

Delhi & NCR
Haryana
Uttar Pradesh
Punjab
Jammu & Kashmir
Rajasthan

East

West Bengal
Orissa
Jharkhand
Assam

West

Maharashtra
Gujarat
Madhya Pradesh
Chhattisgarh

South

Tamilnadu
Karnataka
Kerala
Telangana
Andhra Pradesh

Our network to serve you better

- **200+** Authorised Channel Partners
- **20+** System Integrators
- **25+** Service Centers



We are also there for you 24 hours: hager.co.in



Hager Electro Private Limited
Global Industrial Park
G. No. 185,
Alandi – Ahmednagar Road,
Phulgaon, Pune 412216, India

Branch Office

Hager Electro Pvt Ltd
Awfis Prestige DotCom
16, 2, Residency Rd,
Srinivas Nagar,
Shanthala Nagar,
Ashok Nagar,
Bengaluru, Karnataka 560025

Hager Electro Pvt Ltd
Wework Berger Delhi One,
Sector 16 B, Noida,
Uttar Pradesh – 201301

Hager Electro Pvt Ltd
Wework Futura,
Magarpatta road, Kirtane Baugh
Pune - 411013

Hager Electro Private Limited,
WeWork Zenia Building,
4th Floor, Office No. 102,
Hiranandani Estate Road,
Hiranandani Estate, Thane West,
Thane 400607