

Conduit Pipes & Adapters

Conduit pipes are protective tubes used to encase and route electrical wiring in machinery, automation, railway coaches, automotive application, residential, commercial, and industrial settings.

They provide a safeguard for cables, shielding them from physical damage, moisture, UV exposure, chemical exposure, and other environmental factors.



Conduit pipes can be made from various materials like metal, plastic, or PVC, depending on the specific application and environmental conditions. Flu-con specialise in making high quality polyamide toughened conduits, chemical resistant and anti rodent conduits.

Uses of Conduit Pipes:

Cable Protection: Protect electrical wiring from damage due to abrasion, moisture or accidental impacts.

Organized Wiring: Help neatly route and organize electrical cables, preventing tangled or exposed wiring.

Safety Compliance: Ensure electrical installations meet safety codes by protecting people and equipment from electrical hazards.

Harsh Environment Use: Conduit pipes are essential in industrial or outdoor environments where wiring is exposed to moisture, chemicals or mechanical stress.



Anti Rodent Polyamide Toughened Conduits.

- **Material** : Toughened polyamide 6 , UL-94 HB toughened polyamide 6
- **Ingress protection** : IP 68 with ends properly sealed or in combination with suitable glands
- **Resistant** : Most chemicals & alkalis, good weathering properties, UV stabilised conduits available upon request on MOQ basis.
- **Aditive** : Anti rodent additive
- **Certification / Standard** : RoHS, CE, IEC 61386-1 /61386-23
- **Colour** : International coded orange.
- Flucon anti rodent conduits are suitable for use in under ground appliactions, raceways, sewers, camera cable conduits etc.

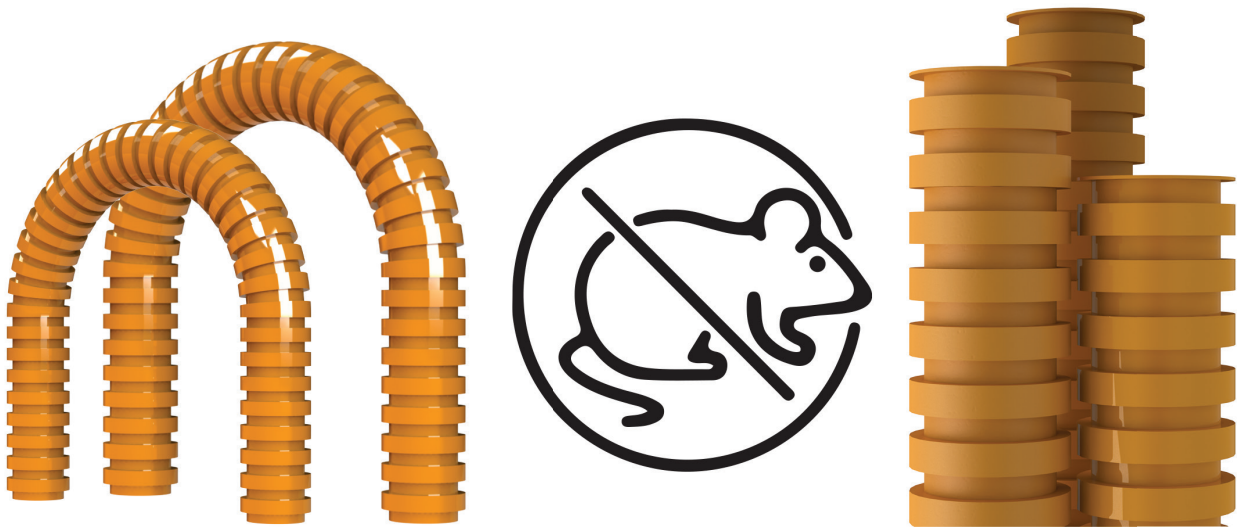

Part Code	Part Description	Dimensions		Bending Radius	Quantity Per Roll	Rolls per Master Bags	Master Bag Quantity	MRP Per Meter
		ID	OD					
		mm	mm		meters	Rolls	meters	Rs.
FCFGNCP0058	FCNCPAR-12 ID	12.00	15.80	30.00	50	10	500	141.00
FCFGNCP0059	FCNCPAR-17 ID	16.20	21.20	40.00	50	6	300	200.00
FCFGNCP0055	FCNCPAR-23 ID	22.60	28.50	42.00	50	4	200	243.00
FCFGNCP0060	FCNCPAR-29 ID	29.00	34.50	55.00	50	3	150	344.00
FCFGNCP0061	FCNCPAR-36 ID	36.50	42.50	62.00	25	3	75	425.00
FCFGNCP0062	FCNCPAR-48 ID	47.50	54.50	72.00	25	2	50	620.00



Flucon Chemical Resist Conduit Pipes .

- **Raw material** : Specially formulated plastic
- **Ingress protection** : IP 65
- **Resistant** : To harsh chemicals, alkalies , chemical fumes and acids
- **Temperature range** : -20° C TO +80°C
- **Certification** : RoHS
- **Colour** : Black Ral 9005

Flucon chemical resistant conduits are suitable for use with chemical pump installation, lift shaft installations, chemical and petroleum tanks and hazardous areas.



Part Code	Part Description	Dimensions		Bending Radius	Quantity Per Roll	Rolls per Master Bags	Master Bag Quantity	MRP Per Meter
		ID	OD					
		mm	mm		meter	rolls	meter	Rs.
FCFGCRP0005	FCCRP-10 ID	9.60	13.00	20.00	50	10	500	85.00
FCFGCRP0004	FCCRP-12 ID	12.00	15.80	30.00	50	10	500	98.00
FCFGCRP0001	FCCRP-17 ID	16.20	21.20	40.00	50	6	300	133.00
FCFGCRP0002	FCCRP-23 ID	22.60	28.50	42.00	50	4	200	185.00
FCFGCRP0003	FCCRP-29 ID	29.00	34.50	55.00	50	3	150	220.00
FCFGCRP0006	FCCRP-36 ID	36.50	42.50	62.00	25	3	75	290.00
FCFGCRP0007	FCCRP-48 ID	47.50	54.50	72.00	25	2	50	415.00



Polyamide Fire Retardent Toughened Conduit. (RDSO Approved)

- **Raw material** : Polyamide 6 toughened
- **Ingress protection** : IP 68 with ends properly sealed or in combination with suitable glands.
- **Resistant** : Most chemicals & alkalis, good weathering properties
UV stabilised conduits available upon request on MOQ basis.
- **Temperature range** : -15°C TO 115°C
- **FR rating** : UL94 V0 (960°C wire)
- **Certification / Approval** : RoHS, REACH, RDSO PE SPEC AC 0138-2009 Rev 2 , IEC 61386-1 /61386-23
- **Colour** : Black Ral 9005

Flucon NW series conduits are suitable for use in railways coach building and are RDSO approved.

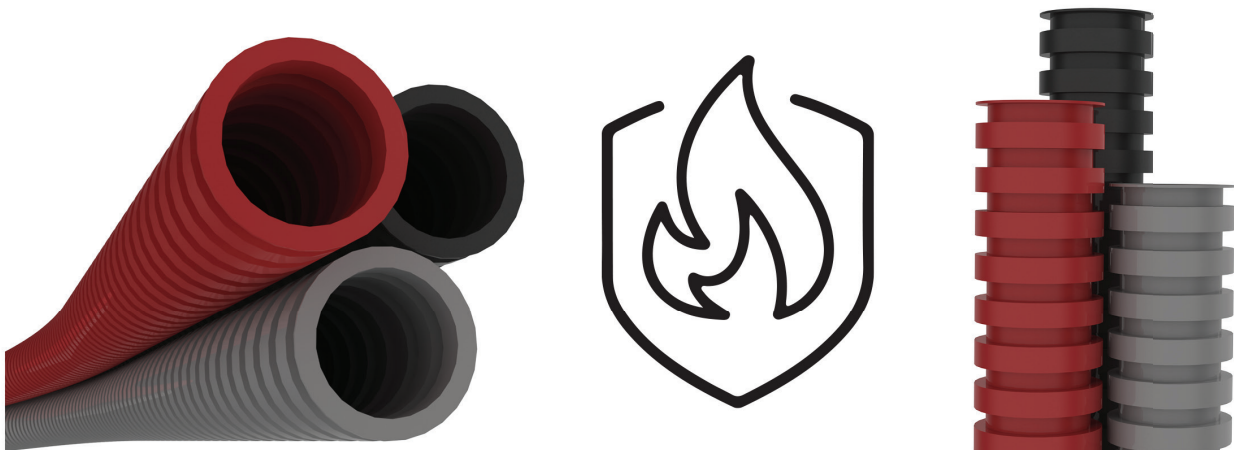

Part Code	Part Description	Dimensions		Bending Radius	Quantity Per Roll	Rolls per Master Bags	Master Bag Quantity	MRP Per Meter
		ID	OD					
		mm	mm		meter	rolls	meters	Rs.
FCFGNCP045	FCNW-10	9.60	13.00	20.00	50	10	500	90.00
FCFGNCP039	FCNW-12	12.00	15.80	30.00	50	10	500	117.00
FCFGNCP040	FCNW-17	16.20	21.20	40.00	50	6	300	163.00
FCFGNCP041	FCNW-23	22.60	28.50	42.00	50	4	200	234.00
FCFGNCP042	FCNW-29	29.00	34.50	55.00	50	3	150	281.00
FCFGNCP043	FCNW-36	36.50	42.50	62.00	25	3	75	340.00
FCFGNCP044	FCNW-48	47.50	54.50	72.00	25	2	50	485.00



Polyamide Twin Slitted Conduits

- **Raw material** : Toughened polyamide 6 , RM UL-94 HB
- **Ingress protection** : IP 55
- **Resistant** : Most chemicals & alkalis, good weathering properties
- **Temperature range** : -10°C TO 90°C

Colour : Black Ral 9005, grey 9016

LENGTH 3 METERS



Part Code	Part Description	Dimensions		Quantity Per Meter	MRP Per Meter
		ID	OD		
		mm	mm	meters	Rs.
FCFGNCP0052	FCNCP-ID 17+23	16.20	21.20	3	227.00
FCFGNCP0063	FCNCP-ID 23+29	22.60	28.50	3	295.00
FCFGNCP0064	FCNCP-ID 29+36	29.00	34.50	3	375.00
FCFGNCP0065	FCNCP-ID 36+48	36.50	42.50	3	513.00

Polyamide Toughened Conduits Slitted.

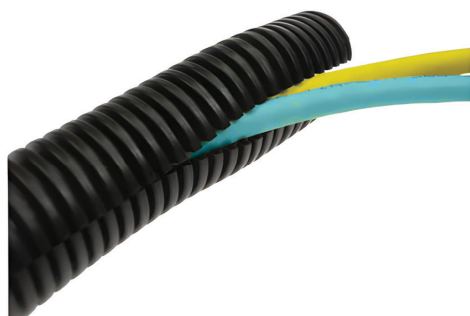

- **Material** : Toughened polyamide 6 , RM UL-94 HB
- **Resistant** : Most chemicals & alkalis, good weathering properties
- **Temperature range** : -10°C to +90 °C
- **Colour** : Black Ral 9005

LENGTH 3 METERS



Part Code	Part Description	Dimensions		Quantity Per Roll	Rolls per Master Bags	Master Bag Quantity	MRP per METER
		ID	OD				
		mm	mm	meters	rolls	meters	Rs.
FCFGNCP0025	FCNCP-12 ID BLACK SLITTED	12.00	15.80	50	10	500	63.00
FCFGNCP0027	FCNCP-17 ID BLACK SLITTED	16.20	21.20	50	6	300	88.00
FCFGNCP0028	FCNCP-23 ID BLACK SLITTED	22.60	28.50	50	4	200	125.00
FCFGNCP0032	FCNCP-29 ID BLACK SLITTED	29.00	34.50	50	3	150	150.00
FCFGNCP0034	FCNCP-36 ID BLACK SLITTED	36.50	42.50	25	3	75	200.00
FCFGNCP0035	FCNCP-48 ID BLACK SLITTED	47.50	54.50	25	2	50	285.00



Polyamide Toughened Conduits

- **Material** : Toughened polyamide 6 , RM UL-94 HB
- **Ingress protection** : IP 68 With ends properly sealed or in combination with suitable glands
- **Resistant** : Most chemicals & alkalies, good weathering properties
UV Stabilised conduits available upon request on MOQ basis.
slitted conduits available on MOQ basis.
- **Tensile modules** : 17300 KGF/cm²
- **Flexural modules** : 8400 K²G/cm
- **Tensile strength** : 590 KG(F)²cm
- **Impact strength** : 20 KG(F)cm
- **Temperature range** : -10°C TO +90°C
- **Certification/Standard** : RoHS, CE, IEC 61386-1 /61386-23

Customised colours available subject to MOQ / Charged 15% EXTRA

Flucon conduits are suitable for in various industries such as automation/railways/ under carriage/machine building etc



Part Code	Part Description	Conduit Size		Quantity Per Roll	Rolls per Master Bags	Master Bag Quantity	MRP Per Meter
		ID	OD				
		mm	mm	meter	rolls	meter	Rs.
FCFGNCP0009	FCNCP- 5 ID	5.1	7.6	200	3	600	45.00
FCFGNCP0010	FCNCP-7 ID	6.4	10	100	5	500	49.00
FCFGNCP0002	FCNCP-10 ID	9.60	13.00	50	10	500	50.00
FCFGNCP0004	FCNCP-12 ID	12.00	15.80	50	10	500	63.00
FCFGNCP0006	FCNCP-17 ID	16.20	21.20	50	6	300	88.00
FCFGNCP0008	FCNCP-23 ID	22.60	28.50	50	4	200	125.00
FCFGNCP0020	FCNCP-29 ID	29.00	34.50	50	3	150	150.00
FCFGNCP0012	FCNCP-36 ID	36.50	42.50	25	3	75	200.00
FCFGNCP0014	FCNCP-48 ID	47.50	54.50	25	2	50	285.00



Quick Coupling Flexible Conduit Gland / Adaptors Suitable For Flucon Flexible Conduits

- Material : Polyamide 6 glass filled
- Colour : Black RAL 9005
- Washer gasket material : Anti slip TPR
- Ingress protection : IP 67



Part Code	Part Description	Threading	Suitable Conduit	Conduit ID	Size OD	Thread Length	Ø C	Master Bag Quantity	MRP Per PCS.
				mm	mm	mm			Rs.
FCFGQCFC0001	QCFC-PG7/10	PG-7	FCNCP-10 ID	9.60	13.00	10.33	12.00	250	25.00
FCFGQCFC0002	QCFC-PG9/10	PG-9	FCNCP-10 ID	9.60	13.00	10.33	15.20	250	31.00
FCFGQCFC0003	QCFC-M12/10	M-12X1.5	FCNCP-10 ID	9.60	13.00	10.33	12.00	250	33.50
FCFGQCFC0004	QCFC-M16/10	M-12X1.5	FCNCP-10 ID	9.60	13.00	10.33	12.00	250	35.50
FCFGQCFC0005	QCFC-PG9/12	PG-9	FCNCP-12 ID	12.00	15.80	10.57	15.20	250	39.00
FCFGQCFC0006	QCFC-PG11/12	PG-11	FCNCP-12 ID	12.00	15.80	10.57	18.30	250	39.00
FCFGQCFC0007	QCFC-PG13.5/12	PG13.5	FCNCP-12 ID	12.00	15.80	10.57	20.00	250	43.00
FCFGQCFC0008	QCFC-M16/12	M16X1.5	FCNCP-12 ID	12.00	15.80	10.57	16.00	250	46.00
FCFGQCFC0028	QCFC-NPT 1/2"/12	1/2" NPT	FCNCP-12 ID	12.00	15.80	10.57	21.00	250	43.00
FCFGQCFC0009	QCFC-PG11/17	PG-11	FCNCP-17 ID	16.20	21.20	13.30	18.30	250	47.00
FCFGQCFC0010	QCFC-PG13.5/17	PG-13.5	FCNCP-17 ID	16.20	21.20	13.30	20.00	250	46.00
FCFGQCFC0011	QCFC-PG16/17	PG16	FCNCP-17 ID	16.20	21.20	13.30	22.50	250	49.00
FCFGQCFC0012	QCFC-M20/17	M20X1.5	FCNCP-17 ID	16.20	21.20	13.30	20.00	250	46.00
FCFGQCFC0013	QCFC-M25/17	M25X1.5	FCNCP-17 ID	16.20	21.20	13.30	25.00	250	49.00
FCFGQCFC0029	QCFC-NPT 1/2"/17	1/2" NPT	FCNCP-17 ID	16.20	21.20	13.30	21.00	250	51.00
FCFGQCFC0014	QCFC-PG16/23	PG-16	FCNCP-23 ID	22.60	28.50	15.00	22.50	250	53.00
FCFGQCFC0015	QCFC-PG21/23	PG-21	FCNCP-23 ID	22.60	28.50	15.00	28.50	250	58.00
FCFGQCFC0016	QCFC-M25/23	M25X1.5	FCNCP-23 ID	22.60	28.50	15.00	25.00	250	54.00
FCFGQCFC0017	QCFC-PG29/29	PG-29	FCNCP-29 ID	29.00	34.50	15.8	36.70	250	88.00
FCFGQCFC0018	QCFC-M40/29	M-40X1.5	FCNCP-29 ID	29.00	34.50	15.8	40.00	250	96.00
FCFGQCFC0019	QCFC-PG36/36	PG-36	FCNCP-36 ID	36.50	42.50	15.8	47.00	100	140.00
FCFGQCFC0020	QCFC-PG42/36	PG-42	FCNCP-36 ID	36.50	42.50	15.8	53.00	100	140.00
FCFGQCFC0021	QCFC-M50/36	M-50X1.5	FCNCP-36 ID	36.50	42.50	15.8	50.00	100	140.00
FCFGQCFC0022	QCFC-PG48/48	PG-48	FCNCP-48 ID	47.50	54.50	15.90	59.00	50	220.00
FCFGQCFC0023	QCFC-M63/48	M-63X1.5	FCNCP-48 ID	47.50	54.50	15.90	63.00	50	220.00



Quick Coupling Flexible Conduit Gland / Adaptors Suitable For Flucon Flexible Conduits NW Series

- **Material** : Polyamide 6 30% glass filled
- **Washer gasket material** : Anti slip TPR
- **FR rating** : UL94 V0 (960°Glow wire)
- **Ingress protection**: IP 68
- **Colour** : Black Ral 9005



RDSO Approved

Part Code	Part Description	Threading	Suitable Conduit	Conduit Size		Thread Length	Ø C	Master Bag Quantity	MRP Per PCS.
				ID	OD				
				mm	mm	mm	Rs.		
FCFGNWA0002	FCPG-9/NW12	PG-9	FCNW-12	12.00	15.80	12.00	15.20	250	108.42
FCFGNWA0004	FCPG-11/NW12	PG-11				18.30	250	124.02	
FCFGNWA0018	FCM16X1.5/NW12	PG13.5				20.00	250	114.68	
FCFGNWA0019	FCM20X1.5/NW12	M16X1.5				16.00	250	161.14	
FCFGNWA0006	FCPG-13.5/NW17	PG-13.5	FCNW-17	16.20	21.20	13.50	20.00	250	157.19
FCFGNWA0008	FCPG-16/NW17	PG16				22.50	250	183.51	
FCFGNWA0020	FCM20X1.5/NW17	M20X1.5M				20.00	250	167.99	
FCFGNWA0022	FCM25X1.5/NW17	25X1.5				25.00	250	210.79	
FCFGNWA0010	FCPG-21/NW23	PG-21	FCNW-23	22.60	28.50	14.00	28.50	250	270.22
FCFGNWA0023	FCM25X1.5/NW23	M25X1.5				25.00	250	217.61	
FCFGNWA0012	FCPG-29/NW29	PG-29	FCNW-29	29.00	34.50	15.00	36.70	250	361.55
FCFGNWA0025	FCM32X1.5/NW29	M-32X1.5				32.00	250	347.25	
FCFGNWA0026	FCM40X1.5/NW29	M-40X1.5				40.00	250	432.20	
FCFGNWA0014	FCPG-36/NW36	PG-36	FCNW-36	36.50	42.50	17.00	47.00	100	550.30
FCFGNWA0027	FCM40X1.5/NW36	M-40X1.5				40.00	100	616.76	
FCFGNWA0028	FCM50X1.5/NW36	M-50X1.5				50.00	100	642.47	
FCFGNWA0016	FCPG-48/NW48	PG-48	FCNW-48	47.50	54.50	17.00	59.00	50	684.74
FCFGNWA0029	FCM50X1.5/NW48	M-50X1.5				50.00	50	672.02	
FCFGNWA0031	FCM63X1.5/NW48	M-63X1.5				63.00	50	1036.23	



Quick Coupling Flexible Conduit Gland / Adaptors Suitable For Flucon Flexible Conduits FCQCP Series

- Raw materials : Polyamide 6 and 66 glass filled
- Colors : Black
- Washer gasket material : Anti slip TPR (Thermo Plastic Rubber)
- Certification/Standards : RoHS/REACH compliant / CE
- Ingress protection : IP 67

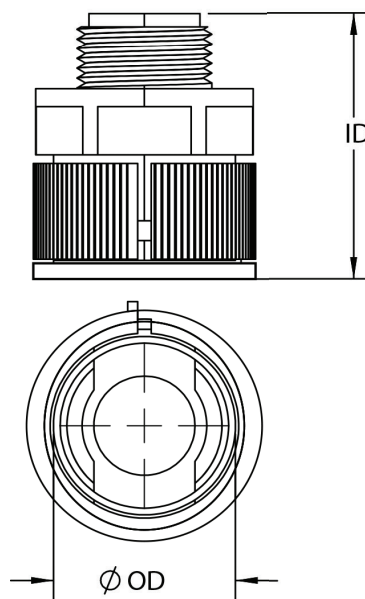

Part Code	Part Description	Threading Type	Suitable Conduit	Conduit Size		Thread Length	Ø C	Master Carton	MRP per PCS.
				ID	OD				
				mm	mm				
FCFGQCP0001	FCQCP-12	M-12X1.5	FCNCP-10 ID	9.60	13.00	14.13	12.00	250	35.00
FCFGQCP0002	FCQCP-16	M-16X1.5	FCNCP-12 ID	12.00	15.80	12.91	16.00	250	42.00
FCFGQCP0003	FCQCP-20	M-20X1.5	FCNCP-17 ID	16.20	21.20	10.37	20.00	250	54.00
FCFGQCP0004	FCQCP-25	M-25X1.5	FCNCP-23 ID	22.60	28.50	11.00	25.00	250	58.00
FCFGQCP0005	FCQCP-32	M-32X1.5	FCNCP-29 ID	29.00	34.50	11.50	32.00	250	75.00
FCFGQCP0006	FCQCP-40	M-40X1.5	FCNCP-29 ID	29.00	34.50	15.00	40.00	250	120.00
FCFGQCP0007	FCQCP-50	M-50X1.5	FCNCP-36 ID	36.50	42.50	18.83	50.00	250	150.00
FCFGQCP0008	FCQCP-63	M-63X1.5	FCNCP-48 ID	47.50	54.50	20.43	63.00	50	220.00



Flexible Conduit Pipe Gland Suitable For PP/PE/PVC Flexible Conduit Pipes

- Raw material - ABS
- Colors available: Black, light grey
- CP glands are available in metric threads
- Specially designed lamelar for effective gripping and sealing of conduit pipes.
- Conduit pipe glands are ideally suited for use where a number of wires are to be passed through a single panel port or machine port.

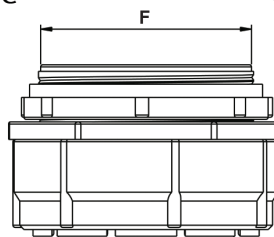

Part Code	Part Description	Conduit Size		Pipe Size		Ø F	Packing Per Carton	Master Carton Quantity	MRP Per Pcs
		mm	ID (mm)	OD (mm)	mm				
FCFGCPA0002	FCCP-16	12	11	16	15.50	25	3000	27.00	
FCFGCPA0005	FCCP-20	16	15	20	18.50	25	2000	28.00	
FCFGCPA0008	FCCP-25	20	19	25	23.50	25	1500	33.00	
FCFGCPA0011	FCCP-32	25	25	32	30.50	25	1000	37.00	
FCFGCPA0014	FCCP-38	30	28	38	38.00	25	500	50.00	
FCFGCPA0017	FCCP-40	32	32	40	38.00	25	500	52.00	
FCFGCPA0020	FCCP-50	40	40	50	49.00	25	500	68.00	

Nylon Straight Cable Glands In Metric Threads

- Standard : Body - polyamide 6
- Sealing : Anti slip thermo plastic rubber (TPR)
- Temperature range : Static -20°C to 80°C
- Ingress protection : IP 64
- Colour : Black

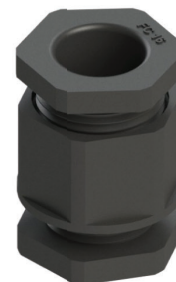
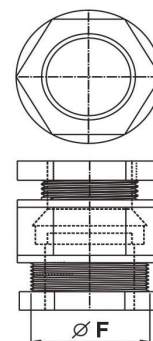

Part Code	Product Description	Cable Range		Ø F	Packing (Pcs)	MRP Per Pcs
		min	max			
FCFGNST0001	FCST-16	2	10	15.00	25	30.00
FCFGNST0002	FCST-20	4	13	19.70	25	38.00
FCFGNST0003	FCST-25	10	19	24.00	25	42.00
FCFGNST0004	FCST-32	16	25	32.50	25	50.00



Flucon Tube Clamps / Pipe Clamps

- **Raw material** : GI calmp and 60/40 natural EPDM rubber.
- **Resistant** : Most chemicals & alkalies, good weathering properties.
- **Colour** : Steel/ Black

Flucon tube clamps are suitable for clamping and fixing conduits to machines, under frames in automotive and rolling stock, automation, etc. It provides a strong, vibration-resistant fixing for conduit pipe.

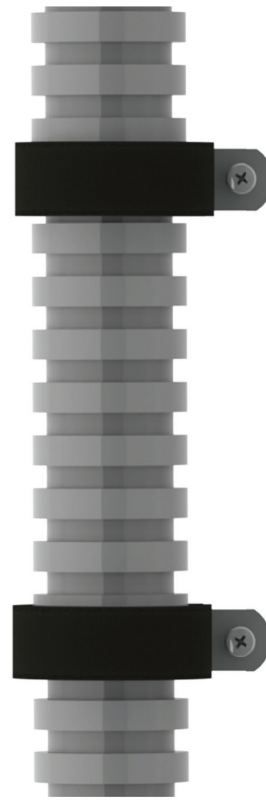

Part Code	Part Description	Suitable Pipe Size	Quantity Per BOX	Master Box Quantity	MRP Per Nos.
			Nos.	Nos.	Rs.
FCFGNWT0001	FCNW-12 TC FR	FCNW-12	100	10	54.00
FCFGNWT0002	FCNW-17 TC FR	FCNW-17	100	10	62.00
FCFGNWT0003	FCNW-23 TC FR	FCNW-23	100	10	70.00
FCFGNWT0004	FCNW-29 TC FR	FCNW-29	100	10	76.00
FCFGNWT0005	FCNW-36 TC FR	FCNW-36	100	10	90.00
FCFGNWT0006	FCNW-48 TC FR	FCNW-48	100	10	101.00